

# TECHNICAL INFORMATION MANUAL

CONTENTS

INTRODUCTION

SUBFLOORS

SHEET

TILES

LVT

LOOSE LAY

ESD

POLYGLAD

WELDING

BORDERS

FINISHES

CHEMICALS

TEMPERATURES

MAINTENANCE



Foreward

## TECHNICAL SUPPORT

At Polyflor, our objective is to support the customer, whether it is the architect, the specifier, the contractor or the end user, by providing all the relevant information necessary to ensure that the maximum benefit is gained from our products in use.

We realise that the performance of our products is dependent upon many factors and that the floor covering itself is only one of those factors. Correct subfloor preparation and dryness, the workmanship of the installer, how the product is maintained and the selection of the correct floor covering are all equally important.

This manual forms part of that support, together with technically trained Sales Representatives, a knowledgeable Customer Technical Services Department (CTSD), maintenance school and an installation training school.

If you have any queries regarding product selection, specification, installation, performance or maintenance of any Polyflor products, then do not hesitate to contact us. Our aim is to resolve problems prior to the installation of our products rather than have problems to resolve after they are installed.

At the date of issue, the data presented is correct. However, Polyflor reserve the right to make changes which do not adversely affect performance or quality.

**Customer Technical Services Department (CTSD)**

Tel: +44 (0) 161 767 1912

Email: [tech@polyflor.com](mailto:tech@polyflor.com)

Find out more at [www.polyflor.com](http://www.polyflor.com)

# CONTENTS

Section one INTRODUCTION 06

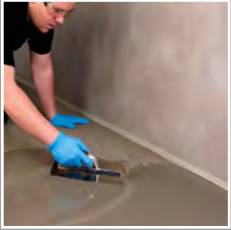

Section two  
PREPARATION OF  
SUBFLOORS  
10



Section three  
INSTALLATION OF  
SHEET  
22



Section four  
INSTALLATION OF  
TILES  
34



Section eight  
INSTALLATION OF  
POLYCLAD  
88

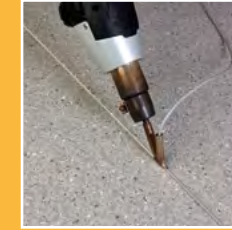

Section nine  
WELDING  
94



Section ten  
INLAID DESIGN &  
BORDERS  
102



Section five  
INSTALLATION OF  
LUXURY VINYL TILES  
46



Section six  
INSTALLATION OF  
LOOSE LAY VINYL  
60



Section seven  
ELECTRO STATIC  
DISSIPATIVE (ESD)  
80

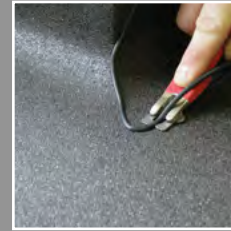

Section eleven  
RECOMMENDED  
FINISHES  
106



Section twelve  
RESISTANCE TO  
CHEMICALS  
114



Section thirteen  
OPERATING  
TEMPERATURES  
116

Section fourteen MAINTENANCE 118

# INTRODUCTION

This manual is intended as a guide to all parties involved in the specification, installation and maintenance of Polyflor vinyl floor covering.

British Standard Code of Practice BS 8203 provides detailed recommendations for the installation of sheet and tile flooring on both new and existing floor constructions and is endorsed by Polyflor for the installation of Polyflor flooring.

This technical information manual is intended as a guide to all parties involved in the specification, installation and maintenance of Polyflor vinyl floor covering. It will not replace the skills of a trained floor layer and Polyflor always recommends the use of reputable flooring contractors, whose experience will prove invaluable at all stages of a project. Selecting a flooring contractor solely on price can lead to a poor installation and a dissatisfied end user.

A successful installation not only depends on the skills of the floor layer but also on the planning of the project prior to installation. Consultation between all parties concerned will eliminate problems and will ensure a successful installation, which meets the design requirements within the allotted time scale.

## 1.1 PRODUCT SELECTION

Selection of the correct floor covering is of paramount importance. Not only must the floor covering meet the designer's initial performance specification but the product performance must be sustainable for the guaranteed life of the product, allowing for foreseeable actions such as general wear and tear and regular maintenance. This is extremely important for the Essential Requirements as defined by the European Union for all construction products.

Consideration at the initial specification stage must be given to the occupational usage of the building and the building type. Particular attention must be paid to the type and intensity of traffic (both pedestrian and wheeled), any special acoustic, electrical resistance or slip resistance requirements, as well as reaction to chemicals and staining agents, and physical properties such as resistance to point and rolling loads.

Should you wish to clarify any points regarding Polyflor flooring or accessories, then please contact Polyflor. The Technical Sales Team or Customer Technical Services Department (CTSD) can provide advice on the suitability, performance and application of any Polyflor products.



### 1.1.1 Project pre-planning

One important consideration at the outset is the maintenance aspects of the floor covering to be installed. Floor coverings with enhanced slip characteristics have a higher surface coefficient of friction and requires different maintenance than a traditional smooth floor covering. Colour also plays a very important part and one should remember that light colours will show soiling more easily and could require a more intensive maintenance programme than darker colours.

Having decided upon your floor covering, it is essential that the product, together with its accessories, are installed correctly within pre-defined time and budget constraints. To achieve this, the tender documentation should include the maximum amount of information possible, such as:

#### KEY POINT

Tender documentation should include the maximum amount of information including detailed handover inspection checklist.

- 1 Full details of the subfloor construction, especially on solid subfloors and any treatments or additives. Include the expected dates for completion of each stage.
- 2 Full details of standard features such as welding, site formed coving or pre-formed coving. In addition, it should include other features such as pattern or border detail and requirements such as door trims, diminishing strips.
- 3 Reference to any tests which must be carried out e.g. for moisture, electrical resistance, screed strength and flatness/level.
- 4 Drawings showing the direction of decoration or where sheet must be laid in a particular direction.
- 5 A statement of the standard of workmanship required, clearly indicating items which will be unacceptable at the handover inspection.
- 6 Full details of finishing requirements. These may include: removal and safe disposal of waste, retention of flooring over a certain size, a construction clean, initial polish where applicable and protection of the finished floor prior to customer handover.

By including this level of detail in the tender document, the flooring contractor is able to give an accurate costing and advise on the length of time required to complete the work at that cost. Once the tender is accepted, ideally discussions should be held to highlight any potential problems well in advance and to ascertain the services required on site when the floor covering is installed.



# PREPARATION OF SUBFLOORS

The quality of a finished installation can be very much dependent upon the preparation of the subfloor and the attention paid to the recommendations made in various local codes of practice and by the manufacturers of the component parts.

The information in this section is provided as guidance based on many years of experience in this field. Ensure reference is always made to local and national standards of the country where the product is to be installed.

It is important to avoid problems at the outset and as such if you are unsure of any of the information listed below, we recommend that you contact the [Polyflor Customer Technical Services Department \(CTSD\)](#) either directly in the UK, through your local distributor for other countries or through our website [polyflor.com](#). Alternatively, discuss your requirements with your preferred supplier of smoothing compounds and adhesives.

## 2.1 NEW CONCRETE AND SCREED BASES

The most common cause of failure in these types of substrate is moisture, either as construction moisture or the lack of an effective moisture barrier on direct to earth subfloors. Failure to adequately control the moisture can subsequently result in debonding of smoothing compounds, adhesives and may promote adhesive related staining of the floor covering.

## 2.2 CONSTRUCTION MOISTURE

Prior to laying any Polyflor vinyl and rubber flooring, it is essential to ensure that all free water, which can affect adhesion, is allowed to evaporate from the base. The rate of drying is influenced by many factors including design of the base, ambient temperature and humidity, concrete quality, amount of construction water used, surface finish attained, use of special concrete additives and especially the thickness of the base. Exact drying out times cannot be provided due to these variabilities, however, as a guide, allow one month per 25mm for the first 50mm and an increasing time for each millimetre above this thickness.

For example, a base 150mm thick in monolithic construction, drying from one face only, can take up to twelve months to dry sufficiently in order to take a floor covering. At the planning stage if it is obvious that there will be insufficient drying time, then the situation should be discussed with Polyflor, who can offer proven alternatives to suppress the construction moisture.

## 2.3 MOISTURE TESTING

Unless specifically stated within the individual product range literature Polyflor flooring should only be laid on subfloors which do not suffer from rising damp or hydrostatic pressure, and where the moisture level does not exceed 75% RH.

The Hygrometer is the only method of test acceptable to Polyflor, and only readings taken over at least a 72 hour period should be considered to represent the moisture content of the subfloor.

Subfloors with a relative humidity in excess of 75% will invariably cause failure of the bond between the substrate and the floor covering, and in

### KEY POINT

Solid substrates should  
**NEVER** exceed 75% RH

some cases, discolour the flooring. To remedy such situations, the whole floor covering will have to be removed, the subfloor treated to resolve the moisture problem and a new floor covering laid. In an occupied building, this can cause severe disruption to the work routine.

To prevent these situations arising, Polyflor does not condone the practice of laying vinyl and rubber floor coverings on subfloors with moisture content readings above 75% RH and accepts no responsibility for non-performance of Polyflor products in such instances.

In countries outside of the UK, alternative moisture measurement methods are also used. Advice on 'Local' regulations should be sought.

## 2.4 EXISTING CONCRETE AND SCREED BASES

Existing concrete and sand/cement screed bases as described in BS 8204, if laid directly to ground, must contain an effective DPM. If one is not present or is suspect, a suitable surface DPM should be applied.

- ▶ In all instances, a cementitious smoothing compound of **at least 3mm thickness** must be applied wherever the Polyflor resilient flooring is to be installed; this must be done prior to the installation of the floor covering. The smoothing underlayment supplier will advise on the correct product to use from their range that suits both the end use application and subfloor construction. If applicable, they will also advise on the correct primer to apply.

### KEY POINT

When installing Polyflor resilient flooring it is **ESSENTIAL** to apply a cementitious smoothing compound of at least 3mm thickness.

## 2.5 POWER FLOATED CONCRETE

Power floated concrete bases as described in BS 8204, if laid directly to ground, must contain an effective DPM. If one is not present or is suspect, a suitable surface DPM should be applied.

- ▶ Smooth dense concrete subfloors – such as those created by a power floated finish – can prove difficult to bond to, due to the impervious nature of the surface. In such instances, the floor should initially be shot blasted to remove the top surface and then made good.
- ▶ In all instances, a cementitious smoothing compound of **at least 3mm thickness** must be applied wherever the Polyflor resilient flooring is to be installed; this must be done prior to the installation of the floor covering. The smoothing underlayment supplier will advise on the correct product to use from their range that suits both the end use application and subfloor construction. If applicable, they will also advise on the correct primer to apply.
- ▶ Surface hardeners or curing agents should not be used with power floated concrete, as these can also impair the adhesion of the floor covering.

## 2.6 MASTIC ASPHALT UNDERLAY

Mastic asphalt underlays as described in BS 8204: Part 5 should conform to BS 6925. Comprising asphaltic cement and suitable aggregates, the asphalt is applied in its hot state onto a glass fibre quilt.

- ▶ Normally a thickness of 15mm to 20mm is applied and the asphalt brought to a finish with a wooden float. The resulting underlay is impervious to moisture and, if continuous with the DPC in the walls, makes an excellent subfloor for Polyflor vinyl and rubber flooring, providing a 3mm thick smoothing underlayment is first applied.
- ▶ The asphalt must not just be skim coated it is important to ensure that the smoothing underlayment is of a type recommended for use on asphalt floors and that a suitable primer key coat is applied if directed.

### KEY POINT

Never apply Polyflor floor coverings directly onto a mastic asphalt subfloor.

## 2.7 MAGNESITE FLOORS

Composition floors which are composed of magnesium oxychloride cement or polyvinyl acetate/cement are highly absorbent. As such, if overlaid with an impervious material, they can break down due to the effects of rising moisture, as the majority of these floors do not incorporate an effective DPM.

- ▶ In all instances where the material is laid directly to ground, Polyflor recommend that the screed be uplifted and relaid incorporating an effective DPM.
- ▶ For floors that are on the first floor or above, cracks and small hollows should be patch filled and a cementitious smoothing compound of **at least 3mm thickness** must then be applied, prior to the installation of the vinyl floor covering. The smoothing underlayment supplier will advise on the correct product to use from their range that suits both the end use application and subfloor construction. If applicable, they will also advise on the correct primer to apply.

## 2.8 TERRAZZO

Terrazzo has a dense hard surface, which is normally impervious. The floor must be sound and firmly fixed and any loose or powdery material removed from the joints.

- ▶ The surface should be thoroughly washed/degreased to remove any surface contaminants and any cracks cleaned out and filled with a suitable resin bonded cement/sand mixture. The surface may also need some mechanical abrasion to enable the smoothing underlayment to key to the surface.
- ▶ In most instances, a cementitious smoothing compound of **at least 3mm thickness** must then be applied prior to the installation of the vinyl floor covering. The smoothing underlayment supplier will advise

on the correct product to use from their range that suits both the end use application and subfloor construction. If applicable, they will also advise on the correct primer to apply.

## 2.9 QUARRY TILES/CERAMIC TILES

Heavily glazed surfaces are quite common with these types of flooring and tiles must be sound and firmly fixed with all loose and powdery grout removed from the joints.

- ▶ Generally the tiles will require mechanical abrasion of the surface in order to provide a key for the application of a smoothing underlayment.
- ▶ The surface should be thoroughly washed/degreased to remove any surface contaminants and then a cementitious smoothing compound of at least 3mm thickness must then be applied prior to the installation of the vinyl floor covering. The smoothing underlayment supplier will advise on the correct product to use from their range that suits both the end use application and subfloor construction. If applicable, they will also advise on the correct primer to apply.

## 2.10 SYNTHETIC ANHYDRITE/CALCIUM SULPHATE/GYPSUM SCREEDS

These types of screed can be difficult to identify – if in any doubt check with one of our approved adhesive manufacturers or the subfloor preparation products manufacturer prior to commencing the installation.

- ▶ Always check the screed for moisture prior to installation. Should you suspect the screed to contain excessive moisture seek advice from one of our approved adhesive manufacturers or the subfloor preparation products manufacturer prior to commencing the installation.
- ▶ These types of screed can also be affected by laitance and moisture in the smoothing compound, resulting in the loss of bond. Any such laitance should be mechanically abraded and fully removed.
- ▶ Anhydrite/Calcium Sulphate/Gypsum screeds also require the application of a special primer before the installation begins. In all instances installations on these types of substrate should be discussed beforehand with one of our approved adhesive manufacturers. If a failure occurs, it is normally below the vinyl floor covering and as such Polyflor will not accept responsibility for failure.

## 2.11 EXPANSION JOINTS

Expansion joints are incorporated into buildings to permit movement without cracking.

- ▶ It is important that these joints extend through the floor covering.
- ▶ Proprietary expansion joint covers are available which blend with the

### KEY POINT

Never lay Polyflor resilient flooring over expansion joints.

floor covering and disguise the joint. Some are made of vinyl that incorporates a flexible portion and are welded to the abutting vinyl to form an impervious layer. Other types are a combination of aluminium and PVC, which again contains a flexible section.

**Filling the expansion joint with sealant which is not specifically designed for expansion joint filling or floor smoothing underlayment will lead to floor failure and is not recommended by Polyflor.**

## 2.12 TIMBER SUBSTRATES

New timber suspended floors should be constructed of either plywood or chipboard specifically manufactured for flooring. Spacing of the supportive joists should be in accordance with the manufacturer's recommendations in relation to the board's thickness.

### 2.12.1 Chipboard

Chipboard floors are widely used as load bearing substrates; however Polyflor recommends that this type of substrate should be overlaid with plywood sheets conforming to EN 636-3 with a minimum thickness of 5.5mm, as described in Section 2.12.6.

- ▶ For joist centres up to 450mm use 18mm thick load bearing chipboard.
- ▶ For joist centres of 610mm use 22mm thick chipboard.
- ▶ All chipboard should comply with EN312, be P grade P4, P5, P6 or P7.
- ▶ Boards must be conditioned on-site by loose laying them individually or loose stacking them in the temperature and humidity conditions which will prevail in service, for at least 3 days prior to fixing.
- ▶ Do not lay boards with a moisture content of less than 7% or greater than 18% (when tested using an electrical resistance moisture meter).

### 2.12.2 Chipboard floating floors

Polyflor recommends that the chipboard floating floors should be overlaid with flooring grade plywood conforming to EN636-3 with a minimum thickness of 5.5mm, as described in Section 2.12.3 below; with the plywood laid half bonded over the chipboard joints, screw fixed or nailed as described in Section 2.12.6.

### 2.12.3 Plywood

- ▶ Plywood should be External Grade Class 3 conforming to EN 636-3 or EN 13986 with one side sanded.
- ▶ The boards should be 1200mm x 2400mm and of minimum thickness 15.5mm.



**KEY POINT**

Do not use sheets with a moisture content of less than 7% and greater than 14% (when tested using an electrical resistance moisture meter).

- ▶ The boards should be laid with the longer side at right angles to the joists and the shorter side must have solid bearing on the joists.
- ▶ Fixing should be carried out at 300mm centres with annular (ring-shanked) nails or lost head nails of length at least 2.5 times the thickness of the board or divergent staples.
- ▶ For joist centres up to 450mm use 15.5mm thick plywood.
- ▶ For joist centres of 610mm use 18mm thick plywood.
- ▶ Plywood sheets must be conditioned on-site by loose laying them individually or loose stacking them in the temperature and humidity conditions which will prevail in service, for at least 3 days prior to fixing.

**2.12.4 Woodblocks/Granwood Flooring**

Although many woodblock floors appear sound, even when overlaid with plywood, the application of an impervious floor covering on a direct to earth subfloor can cause expansion and lifting of the base.

Polyflor recommends that, in all cases, the woodblock floor be removed and the subfloor brought up to the required standard to accept Polyflor resilient flooring.

**2.12.5 General**

- ▶ All nail and screw heads must be below the surface of the board and any indentation filled with a suitable flexible underlayment, as should the joints between any boards that have been used to overlay the existing floor.
- ▶ Due to the extensive choice available of these types of smoothing compounds and differing opinions on priming; Polyflor recommends that advice is sought beforehand with a suitable subfloor preparation manufacturer.
- ▶ Please note that priming will minimise adhesive usage and maintain the open time of the adhesive and prevent preferential absorption.

**2.12.6 Existing wooden floors**

Existing wooden floors may have received a preservative treatment that will cause poor bonding, due to a chemical interaction between the preservative and the adhesive. In such cases, they should not be laid onto directly.

- ▶ All loose boards should be firmly nailed to the joists and any worn or broken boards replaced. The floor should be sanded to remove high spots and any hollows or cracks filled with a suitable flexible underlayment.

- ▶ The existing wooden floors should then be overlaid with suitable flooring grade plywood of a minimum thickness of 5.5mm which conforms to EN636-3.
- ▶ The sheets should be laid with staggered joints.
- ▶ The plywood should be fixed to existing floorboards using suitable annular ring shank nails of minimum 20mm length; or suitable countersunk wood screws.
- ▶ Fixings should be at 100mm centres along the edge of each sheet, with a fixing line 12mm from the edge and thereafter at 150mm centres throughout the entire area of the sheet.
- ▶ Perimeter fixings must not be more than 18mm from the board edges.
- ▶ Plywood should be conditioned as described in Section 2.12.3 prior to application of the floor covering.
- ▶ With suspended timber at ground level, it is of vital importance to obtain good ventilation below the floor through the existence of air bricks. Without good ventilation, the application of an impervious floor covering could lead to dry rot in the structure beneath. Always seek advice from the smoothing underlayment manufacturer for the correct product for your specific application.

**2.13 OTHER SUBSTRATES****2.13.1 Metal bases**

Metal bases are generally, but not exclusively, steel and can be contaminated with rust or oxidisation, oil and grease.

- ▶ The surface should be thoroughly degreased and then abraded or wire brushed to remove the rust or oxidisation.
- ▶ Any high spots may need to be ground off.
- ▶ In most instances, but not where there is excessive vertical or lateral flexing or movement, a suitable cementitious smoothing compound of at least 3mm thickness must then be applied prior to the installation of the vinyl floor covering. The smoothing underlayment supplier will advise on the correct product to use from their range that suits both the end use application and subfloor construction. If applicable, they will also advise on the correct primer to apply.

**2.13.2 Painted or epoxy coated floors**

- ▶ Epoxy and polyurethane surface coatings should be removed, in order to ensure that no breakdown of the sub-floor occurs after installation of the resilient floor covering.

- ▶ Painted floors will impair the adhesion of the resilient floor covering and should be removed prior to the application of the floor covering. Mechanical methods such as grinding or blasting are the most suitable methods for removing these coatings. However, where the paint proves difficult to remove, the floor may need to be scabbled. If the epoxy coating is well bonded to the subfloor, it is possible to apply the floor covering after grinding or blasting.
- ▶ In both instances, the surface should then be made good with a 3mm minimum coating of a suitable cementitious smoothing underlayment applied in accordance with the manufacturer's recommendations, which may include the application of a primer key coat.

### 2.13.3 Loose lay isolating membranes

Polyflor recommend that subfloors be prepared in accordance with the relevant code of practice BS 8203. Any installations incorporating loose lay isolating membrane systems within the marketplace, which are used to overlay contaminated subfloors, existing floor coverings, etc. are solely underwritten by the individual membrane manufacturer.

### 2.13.4 Existing floor coverings

Unless specifically stated within the individual product range literature Polyflor resilient flooring should never be laid over existing floor coverings and in such instances where this is carried out, Polyflor accepts no responsibility for non-performance of its products.

- ▶ All existing floor coverings must be uplifted and as much as possible of the old adhesive removed from the subfloor.
- ▶ Special care must be taken on very old floors, as some products – but not Polyflor – contained asbestos. In these instances, contact Polyflor for further information.
- ▶ The removed floor coverings should be reclaimed and recycled, providing that there is no heavy contamination. Polyflor is one of two founder members of Recofloor, the industry funded vinyl take-back scheme.
- ▶ A suitable floor smoothing underlayment with a minimum thickness of 3mm should then be applied to the whole floor. Failure to remove sufficient adhesive can lead to premature failure of the underlayment.
- ▶ After uplifting existing floor coverings laid on plywood, used as fabricated underlay, replacing the plywood is almost always necessary.
- ▶ After uplifting existing floor coverings laid on suspended chipboard; hardboard or plywood subfloors, plywood sheet with a minimum thickness of 5.5mm should then be applied to the subfloor as described in Section 2.12.6.

#### RECOFLOOR

To enquire about recycling end of life vinyl flooring (uplifted and off-cuts), email Recofloor at [info@recofloor.org](mailto:info@recofloor.org)



### 2.13.5 Access Panels

When access is no longer required beneath a floor and it is proposed for access panels to be overlaid, provided the panels are sound and level, Polyflor would recommend that a minimum 5.5mm Ply sheet as described in section 2.12.6 is installed over the access panel and adequately fixed.

A suitable smoothing compound should then be used to fill any joints and hollows as described in section 2.12.5.

### 2.13.6 Subfloors

In common with the installation of any type of flooring, the subfloor should not only be in sound condition, but also free of any contaminants, like oil, paint, preservative treatments in fact anything that may impair adhesion must be removed prior to installation. Other forms of marking, such as a permanent marker pen must also be removed. Similarly, no markings should be applied to the back of heterogeneous flooring.



Figure 2.1 Spiked screed roller

### 2.13.7 Surface Regularity

Close attention must also be paid to subfloor levelling. Level, smooth subfloors will vastly improve the aesthetic appearance of any finished floor covering installation. This is of particular importance when installing Homogeneous Vinyl Tiles; Rubber Tiles and Luxury Vinyl Tiles.

Polyflor's recommendation would be that the surface regularity should not deviate by more than 5mm when measured using a slip gauge or similar accurate measuring device under a 2m straight edge. When installing intricate Luxury Vinyl Tile; waterjet; and plain coloured sheet and tile designs a higher degree of surface regularity maybe required with deviation not exceeding 3mm when measured the same way as above.



# Floor Laying

TRAINING COURSES

Refresh, develop and hone your installation skills with comprehensive training courses from Polyflor, the UK's leading vinyl floor covering manufacturer.



Polyflor is the destination to develop your skills in the art of floor laying – with course content suitable for a range of experience levels, from seasoned flooring contractors to apprentices just starting out in the trade.

The two, three and four day courses all take place at the Polyflor Training School in Manchester, covering subfloor preparation, adhesives and fitting the perfect floor.



# INSTALLATION OF SHEET

The installation of Homogeneous, Heterogeneous, Rubber and Safety vinyl sheet.

## 3.1 RECEIPT & STORAGE

On receipt of rolls:

- ▶ Check that colours correspond to those ordered, that quantities are correct and that there is no damage.
- ▶ In particular, check that rolls are from one batch, if that was requested on the order.
- ▶ On arrival at site, the rolls should be safely secured in an upright position; (2m widths only) and stored, together with the adhesive, at a minimum temperature of 18°C for at least 24 hours before laying.
- ▶ Inflammable adhesives require special storage conditions. Contact the adhesive manufacturer or see current literature for details.
- ▶ To achieve best results, site conditions should be as described in BS 8203 or prevailing local/national standards. A working temperature of between 18°C and 27°C is required for at least 48 hours prior to, and during, the installation period; and for 24 hours afterwards. Conditioning should be carried out in the same room or areas as the installation, to prevent thermally induced dimensional changes.

## 3.2 PRIOR TO INSTALLATION (UNDERFLOOR HEATING)

On installations where underfloor heating is used:

- ▶ The system should be fully tested and commissioned prior to the flooring installation commencing.
- ▶ Underfloor Heating systems should be switched off and be fully cooled for a minimum of 48 hours prior to the installation commencing. The system should remain off and fully cooled during the installation and for a minimum of 48 hours afterwards. It should then be slowly brought back up to the working temperature incrementally over several days.
- ▶ A maximum subfloor temperature; (at the adhesive line) of 27°C should never be exceeded. Specialist high temperature adhesives should be used in areas with underfloor heating, direct sunlight, and areas of high solar gain. Please refer to the Polyflor Approved Adhesive List or contact your adhesive manufacturer for more information.

## 3.3 PREPARATION OF WORK AREA

The work area should now be prepared to receive the sheet flooring.

- ▶ Ensure that all other trades have completed their work and removed all their equipment and materials.
- ▶ Remove all debris and vacuum the whole subfloor area.
- ▶ Check the condition of the subfloor and make good as necessary.



**KEY POINT**

Commencement of work is deemed by many as acceptance of the site conditions as suitable for laying floor coverings.

- ▶ Stone or power grind any cementitious subfloor to remove any 'nibs' or ridges.
- ▶ Remove any surface contaminants, which may affect adhesion. Sweep or vacuum again prior to laying.
- ▶ If required by the contract, or if in doubt, check the moisture content of the subfloor and record the results and method used. Good lighting is essential.
- ▶ It is important to note that commencement of work is deemed by many as acceptance of the site conditions as suitable for laying floor coverings.

 Further information on subfloors and subfloor preparations can be found in Section two.

**3.4 LAYOUT OF SHEET**

- ▶ The architect may have provided a drawing showing the direction in which the material should be laid. In this case, lay the sheet as directed.
- ▶ Where the architect has left the direction to the discretion of the flooring contractor; at the tender stage show in which direction the material will be laid and state that your estimate is based on this.
- ▶ Always pay particular attention to where seams will fall, avoiding such occurrences as seams in the centre of doorways.
- ▶ If large windows are installed, minimise the effect of the joints by laying towards the window.

**3.5 SLABBING THE SHEET**

- ▶ Polyflor recommends that all Polyflor sheet flooring be rolled out face upward, taking care not to damage the surface, and cut approximately to size.
- ▶ Allowance of at least 75mm should be made at the ends for trimming in, the slabs should then be left overnight for 24 hours, to condition at a minimum temperature of 18°C.

**3.6 FITTING THE FIRST LENGTH**

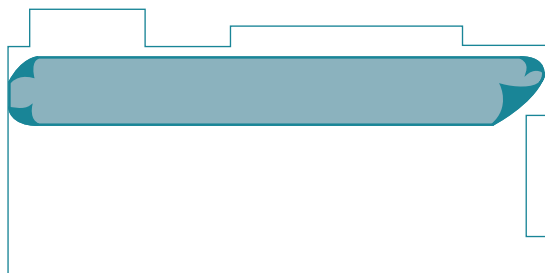

Figure 3.1 Lining up the First Sheet

- ▶ Place the first sheet in position next to the wall with the outer edge approximately 15mm from the nearest point.
- ▶ Adjust the lie of the sheet so that the inner edge is parallel with the axis of the room (Figure 3.1).
- ▶ Depending upon the depth of the recesses, use either a bar scriber or a pair of scribes to trace the profile of the wall. The scribes should be set to allow for the deepest recess or rake of the wall. Holding the scribes vertically and square to the edge, trace the wall profile onto the face of the sheet (Figure 3.2). With this method, all irregularities of the wall will be accurately reproduced onto the surface of the sheet. If the scribed line is difficult to see due to the colour or decoration, rub suitably contrasting chalk dust into the line to highlight it.



Figure 3.2 Scribing the wall profile

- ▶ Ease the sheet away from the wall and, using a hook blade trimming knife, cut off the excess material to the scribed line. Slide the sheet back against the wall and check the fit, making any minor adjustments as necessary.
- ▶ When satisfied that the fit on the first edge is correct, use a pencil to trace the opposite edge onto the subfloor (line A-B in Figure 3.3).
- ▶ In the centre of the room, draw a line on both the sheet and subfloor square to the main axis of the sheet (line C-D in Figure 3.3).

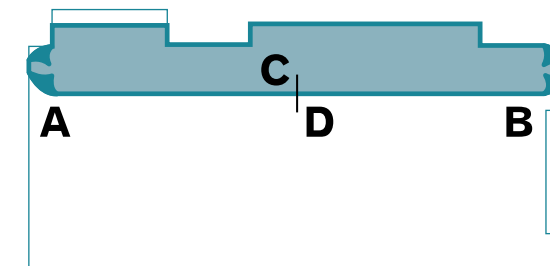

Figure 3.3 Marking the position

**KEY POINT**

If fitting to set-in coving, the same principles apply but a reverse scribe must be used to trace the toe onto the sheet.

It is normal to free hand cut to the coving, allowing 12mm overlap for final trimming in.

- ▶ Keeping the inner edge of the sheet on line A-B, slide the sheet back to clear the wall at one end of the room.
- ▶ Set the scribers to the distance now between lines C and D (Figure 3.4). Trace the end wall profile and cut to fit as described earlier.
- ▶ Repeat for the other end of the sheet. Once completed, the whole sheet - when slid back into position - should fit the wall profiles exactly.

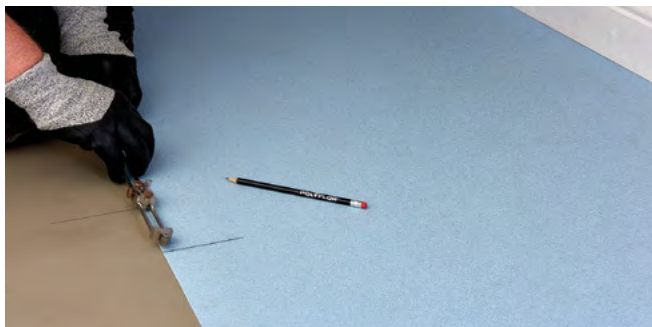

Figure 3.4 Setting the scribe

**3.7 FITTING SUBSEQUENT LENGTHS**

- ▶ Place the second length parallel to the first length, with a minimum of 10mm overlap along the adjoining edges or overlap of selvage.
- ▶ On the opposite side, trace the edge along the whole length onto the subfloor. In the middle, draw a line C-D at right angles to the main axis, as previously described.
- ▶ Using the longitudinal line as a guide, slide back the sheet from the end wall and fit as described in Section 3.6.
- ▶ Repeat for the opposite end.
- ▶ Repeat the sequence for all remaining lengths.
- ▶ On the final length, which abuts the opposite wall, fit as described for the first length (Section 3.6).

**3.8 ALIGNMENT OF DECORATION (HETEROGENEOUS RANGES ONLY)**

This type of floor covering features a print layer with a regular, repeat decoration (e.g. wood plank). With wood effect designs:

- ▶ To maximise the final appearance of the installation and to ensure the decorative effect is not lost, it is important that care is taken to align the decoration of each adjacent sheet.
- ▶ The edge of the printed plank can be used in the lengthwise direction as a guide.

The label and printed information on the backing of the sheet must be checked and the product reverse laid when instructed.

**3.9 CUTTING IN THE SEAMS**

Polyflor recommends that all Polyflor sheet floor coverings are welded. Trimming off the factory edges and seam cutting is a prerequisite to enable successful grooving and welding.

**Note:** The seams should be cut before the adhesive is applied.

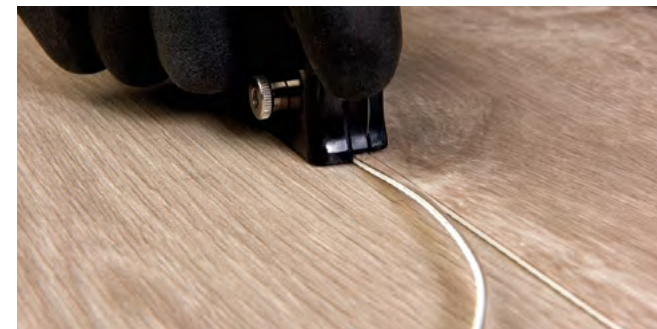

Figure 3.5 Cutting in the seams

**3.10 ADHERING THE SHEET**

Use of the correct adhesives is of paramount importance for the installation to be successful. Polyflor provide a comprehensive approved adhesive list available at polyflor.com or by contacting the **Polyflor Customer Technical Services Department (CTSD)**.

In areas subjected to direct sunlight or extremes/fluctuations in temperatures, Polyflor always recommends the use of an approved polyurethane; epoxy or suitable high temperature adhesive. Polyflor provides this information only as guidance. The legal responsibility for the supply and performance is that of the adhesive manufacturer.

Prior to adhering the sheet, it is important to read and understand the adhesive manufacturer's instructions, recommendations and safety advice. You need to know the hazards and limitations of the adhesive, especially the open time.

- ▶ Spread the adhesive using a suitable trowel to the manufacturer's recommendations ensuring that the correct notch size is maintained throughout the installation. If the notch shows signs of wear the trowel should be renewed immediately.
- ▶ If pressure sensitive adhesive is used the resultant serrated adhesive edges should be flattened with a lambswool roller pre-wetted with adhesive.
- ▶ Never spread more adhesive than can be laid within the open time. Polyflor does not recommend any method of adhesive application, such as spraying, which cannot guarantee the spread rate.

**KEY POINT**

Always follow the approved adhesive manufacturer's instructions closely.

- ▶ After each section has been laid, with the exception of the perimeter, thoroughly roll the sheet in both directions with a 68kg articulated floor roller. Repeat for each section until the main field of sheet has been laid.
- ▶ When spreading dispersion based adhesives on impervious or non-porous bases; (including bases where a surface applied damp proof membrane or moisture vapour suppressant has been applied) it is important to apply a suitable smoothing compound of not less than 3mm thickness. Failure to apply the correct depth of smoothing compound can result in moisture becoming trapped between the sheet and the impervious or non-porous base. This can ultimately lead to failures in the adhesive bond and in some cases discolouration of the vinyl sheet products.

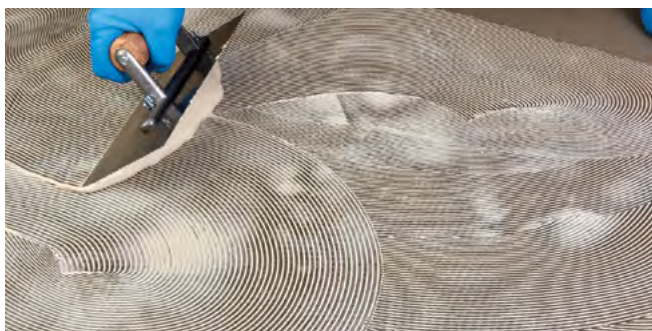

Figure 3.6 Spread the adhesive

- ▶ The smoothing underlayment or adhesive supplier will provide details on which product(s) within their range should be used to suit the end use application and subfloor construction, and where applicable details of which primer should be used.
- ▶ Adhesive selection should be based on both the floor covering; substrate type and site conditions. Always select an adhesive from the Polyflor Approved Adhesive list. If in doubt about adhesive choice please contact [Polyflor CTSD](tel:+441617671912) on +44 (0) 161 767 1912.

### 3.10.1 Premature trafficking of newly laid floors

Early trafficking may disturb the adhesive bond and weaken it, resulting in the associated problems of tracking, indentation, debonding etc. After the sheet has been installed, only light foot traffic should be allowed for at least 24 hours. Furniture etc. should only be returned after this time. The material should be protected with hardboard or plywood for at least 48 hours if subject to heavy trafficking.

## 3.11 PATTERN TEMPLATE METHOD

Areas which call for a considerable amount of fitting around obstacles, or which are too confined to lay down a sheet for fitting by normal methods, can be dealt with by templating the floor in felt paper.

For new buildings consider coming to an agreement with the main contractor to fit fixtures such as WCs and sinks after the vinyl has been laid.

- ▶ Dry fit the area with felt paper, leaving a gap of 15mm to 20mm around obstructions and walls.
- ▶ Draw around the fittings using a suitable measuring and marking device. Mark the template 'This Side Up'.
- ▶ Place the sheet in a larger area with the face uppermost. Place the template on top ensuring the direction of decoration is correct. Secure the template firmly in position and mark the position of all obstacles using the template as a guide.
- ▶ Using a sharp trimming knife, cut the sheet to the marked lines and fit into position.

**Do not use the felt paper template as an underlay.**

## 3.12 PREPARATION FOR SKIRTING PROFILE

- ▶ Ensure that all surfaces are firm, dry and free of dust, grease and oil.
- ▶ Fair faced brickwork or block work should have a skim coat applied, as this provides a smooth, firm surface of known porosity which will minimise adhesive usage and improve adhesion. Alternatively, 5.5mm thick plywood can be cut into appropriate width strips and then securely fixed to the block work to provide a smooth surface onto which the skirting can be fitted.
- ▶ Surfaces may require priming prior to application.
- ▶ All painted surfaces must be stripped back and wire brushed to remove all traces of paint as this can impair adhesion.

## 3.13 SITE FORMED COVERED SKIRTINGS

Polyflor fully flexible flooring, in conjunction with the Polyflor Ejecta cove former range (see also Section 11) can be used to create site formed covered skirting to form a hygienic watertight finish.

- ▶ Adhere the sections of cove former using an approved contact adhesive. Use a mitre-block to accurately cut internal and external corners and only adjust for length on straight cuts.

Learn  
how to use  
templates on the  
3 & 4 day Polyflor  
Floor Laying  
Courses

**ACOUSTIC FLOOR**

Polyflor Acoustic Flooring ranges are not normally site formed. For further advice contact Polyflor CTSD +44 (0) 161 767 1912



Figure 3.7 Taper towards a doorway

- ▶ To prevent a difficult fit, and potential weak spot near doorways, cut away the back edge of the cove former on a taper for 150mm so that there is minimal cove former near the doorway (Figure 3.7). Heating the cove former will enable the shape to be formed but do not use a naked flame.

**3.13.1 Fitting Ejecta capping strip (type CS-N) Figure 3.6**

**KEY POINT**

Use only the Contact Adhesives that appear on the Polyflor Approved Adhesive List relevant to the product installed.

- ▶ Mark the walls around the room to the height the coving will reach. Minimum 100mm or as directed.
- ▶ Place the sheet to the walls and mark to the same height as previous. Using a straight edge and sharp knife, trim off the excess.
- ▶ Pull back the sheet from the walls. Fit the capping strip to the wall with a Polyflor approved contact adhesive so that the top of the sheet will sit inside the cap.
- ▶ Using the Polyflor approved contact adhesive, apply to the face of the cove former and up to the capping strip. Coat the back of the sheet with contact adhesive and leave both to dry.
- ▶ When dry, push the sheet into place and tuck the top edge into the capping strip. Roll with a hand roller to ensure even contact.

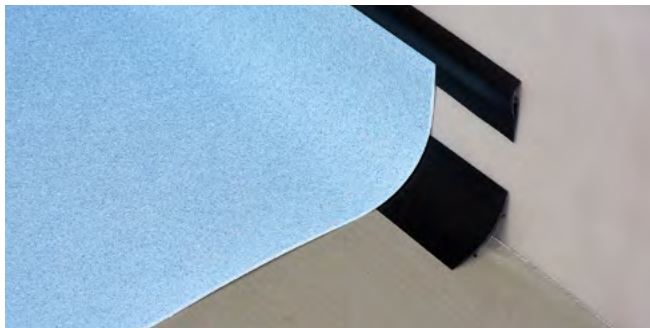

Figure 3.6 CS-N capping strips

**3.13.2 Fitting with sit-on capping strip (Type CS) Figure 3.7**

- ▶ Mark the walls around the room to the height the coving will reach. Minimum 100mm or as directed.
- ▶ Apply a Polyflor approved contact adhesive to the face of the cove former and up to the marked line on the wall. Coat the back of the sheet with the contact adhesive and leave both to dry.
- ▶ When dry, push the sheet into place and roll with a hand roller to ensure even contact.
- ▶ Using a straight edge and sharp knife, trim off the excess back to the required height as described earlier.
- ▶ Using a piece of capping strip, mark where the strip overlaps the wall and sheet. Apply a Polyflor approved contact adhesive between the lines and to the back of the capping strip. When dry, push into place.

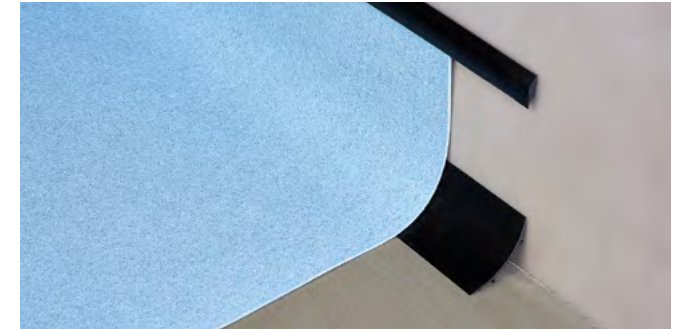

Figure 3.7 CS Capping strip

**3.14 FITTING TO CERAMIC WALL TILES (CT strip) Figure 3.8**

For the junction between site formed coved skirting and ceramic wall tiles, Polyflor Ejecta CT strip should be used.

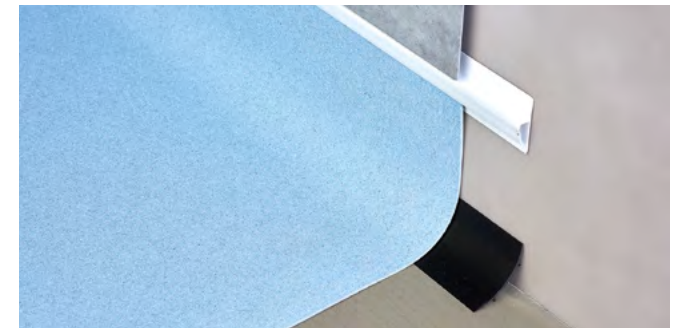

Figure 3.8 Fitting to Ceramic tiles



The flexible section is designed to accept ceramic tiles on one side and various gauges of material on the other.

- ▶ The Polyflor CT strip should be adhered using a Polyflor approved contact adhesive.
- ▶ The edge between the CT strip and the ceramic tiles should be grouted.
- ▶ The Polyflor sheet should be fitted into the bottom edge of the CT strip and adhered to the wall using a contact adhesive as recommended by Polyflor. A thin bead of mastic sealant should be run along the underside edge of the CT strip and the Polyflor sheet.

### 3.15 FITTING OF AN EXTERNAL CORNER (Wrap around method)

Welded external corners can be prone to damage from wheeled traffic. To prevent this, use the 'wrap around' method (illustrated in Figure 3.9).



Figure 3.9 External corners 'wrap around method'



For further details on recommended finishes refer to Section eleven.



# INSTALLATION OF TILES

The installation of homogeneous or rubber tiles. For installation of luxury vinyl tiles refer to Section five.

## 4.1 RECEIPT & STORAGE

- ▶ Check that colours correspond to those ordered, that quantities are correct and there is no obvious damage.
- ▶ In particular, check that tiles are from one batch, if that was requested on the order.
- ▶ On arrival at site, the tiles should be stored indoors, together with the adhesive, at a consistent temperature of between 18°C and 27°C for at least 24 hours prior to laying.
- ▶ Following off-loading, boxes should be stacked no more than **five** high during the conditioning period. The boxes should be opened and conditioned in the area where they are to be installed.



Figure 4.1 Site Conditions

- ▶ To achieve best results, site conditions should be as described in BS 8203. A working temperature of between 18°C and 27°C is required for at least 48 hours prior to, and during, the laying period and for 24 hours afterwards. Conditioning areas and laying areas should be of similar temperature, to prevent thermally induced dimensional changes.

## 4.2 PRIOR TO INSTALLATION (UNDERFLOOR HEATING)

On installations where underfloor heating is used:

- ▶ The system should be fully tested and commissioned prior to the flooring installation commencing.
- ▶ Underfloor Heating systems should be switched off for a minimum of 48 hours prior to the installation commencing. The system should remain off and fully cooled during the installation and for a minimum of 48 hours afterwards. It should then be slowly brought back up to the working temperature incrementally over several days.
- ▶ A maximum subfloor temperature; (at the adhesive line) of 27°C should never be exceeded.

- ▶ Specialist high temperature adhesives should be used in areas with underfloor heating, direct sunlight, and areas of high solar gain. Please refer to the Polyflor Approved Adhesive List or contact your adhesive manufacturer for more information.

### 4.3 PREPARATION OF WORK AREA

The work area should now be prepared to receive the tiles.

- ▶ Ensure that all other trades have completed their work and removed all their equipment and materials.
- ▶ Remove all debris and vacuum the whole subfloor area. Check the condition of the subfloor and make good as necessary.
- ▶ Stone or power grind any cementitious subfloor to remove any 'nibs' or ridges. Remove any surface contaminants, which may affect adhesion.
- ▶ Sweep or vacuum again prior to laying.
- ▶ If required by the contract, or if in doubt, check the moisture content of the subfloor and record the results and method used.
- ▶ Good lighting is essential.

 Further information on subfloors and subfloor preparations can be found in Section two.

### 4.4 LAYOUT OF TILES

#### KEY POINT

When setting out tiles, always start from the centre of the room

Although many floor layers regard tiles as being easier to lay than sheet, the layout of the tiles can be critical to the success of the installation.

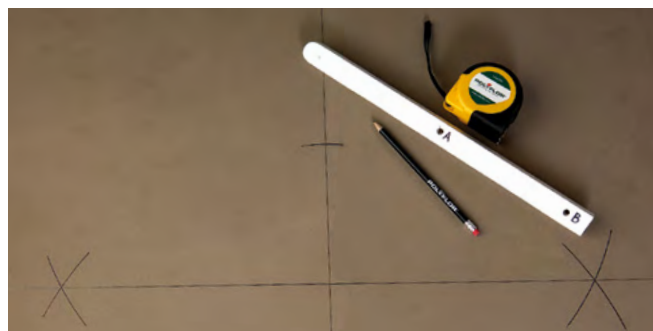
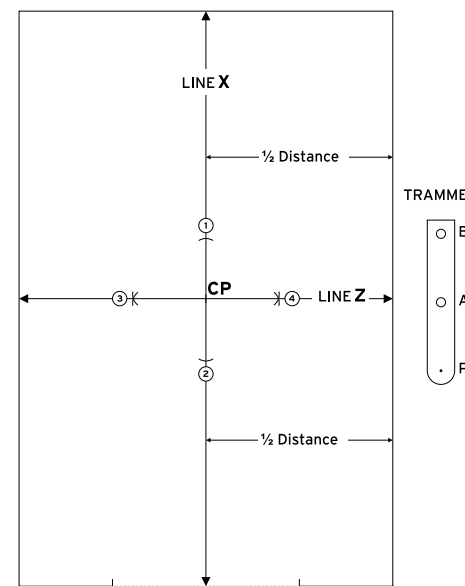

Figure 4.2 Measuring and marking out

- The regular form of tiles, especially when laid in contrasting colours, can accentuate deviations in the building line emphasising the need for detailed planning of the layout.
- Work from the centre of the room and loose lay tiles to check the layout will make the final appearance correct from any viewpoint. This is especially important where a geometric design is incorporated into the floor.

### 4.5 MEASURING AND MARKING OUT

#### 4.5.1 Straight Tiling – Setting Out



- ▶ Measure the room to be laid, in both directions, including any alcoves.
- ▶ Mark a centre line X. Ensure it is central to the room dimensions.
- ▶ Loose lay tiles to ensure there are no small cuts at the perimeter. If small strips are evident, move the centre line across half a tile in either direction to create an acceptable sized cut.
- ▶ Find the centre of line X and mark the Centre Point (CP).
- ▶ Mark arcs 1 & 2 at equal distances from CP on the centre line using point A on your trammel.
- ▶ With points 1 & 2 as centres, use point B on your trammel to draw further arcs intersecting at 3 & 4.
- ▶ Strike a line through point 3 & 4 ensuring it passes through CP.
- ▶ Line Z is now 90° to line X.
- ▶ Double check using the 3,4,5 method.

#### 4.5.2 Diagonal Tiling – Setting Out

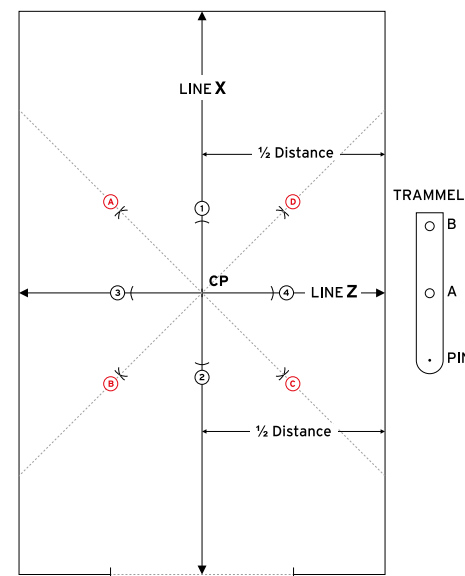

- ▶ Set out as overleaf for straight tiling. Ensure both lines are at 90° to each other.
- ▶ At CP (Centre Point), use point B on your trammel to mark arcs at 1, 2, 3 and 4.
- ▶ With points 1 & 3 as centres using point B on your trammel draw arcs to intersect each other at A.
- ▶ With points 2 & 4 as centres using point B on your trammel draw arcs to intersect each other at C.
- ▶ Strike a chalk line from wall to wall through points A & C; if no error has been made, this line will pass through CP.
- ▶ With points 1 & 4 as centres using point B on your trammel draw arcs to intersect each other at D.
- ▶ With points 2 & 3 as centres using point B on your trammel draw arcs to intersect each other at B.
- ▶ Strike a chalk line from wall to wall through points B & D; if no error has been made, this line should pass through CP.
- ▶ Double check using the 3,4,5 method.

Find out more about setting out tiles on the 3 & 4 day Polyflor Floor Laying Courses

#### 4.6 SPREADING THE ADHESIVE

- ▶ Once the start point has been established, depending on the size of the area and the type of adhesive to be used, it may be necessary to section off the area so that the adhesive can be applied to areas that can be laid within the open time.
- ▶ Always follow closely the approved adhesive manufacturer's instructions.
- ▶ Spread the adhesive using a suitable trowel to the manufacturer's recommendations ensuring that the correct notch size is maintained throughout the installation.
- ▶ If the notches on the trowel shows signs of wear, renew immediately.
- ▶ If using a Polyflor approved pressure sensitive adhesive it may be necessary to flatten out any resultant serrated adhesive edges using a lambswool roller pre-wetted with adhesive to prevent 'grin through' once the installation has been completed.
- ▶ When a section has been laid, except for the perimeter, it should be thoroughly rolled in both directions with a 68kg articulated floor roller. Repeat for each section until the main field of tiles has been laid.
- ▶ It is advantageous to leave the last full tile or plank and the cut at the perimeter without adhesive until all planks have been cut to size.

#### 4.7 ADHERING THE MAIN FIELD OF TILES

##### KEY POINT

Directional or marbled tiles need 'shuffling', and require laying in alternating directions.

- The decoration of tiles on some product ranges is randomly distributed and in marbled styles can be heavier on some tiles than others. To prevent 'heavy' and 'light' areas, the tiles should be unboxed and, if required, 'shuffled'.
- ▶ Ensure the backs of the tiles are free from dust prior to laying.
  - ▶ Once the adhesive is ready to accept the tiles, place the first tile at the starting point, which is the intersection of the two centrelines. Press well down in the centre of the tile and then run a thumb around the edge, ensuring that all air is expelled.
  - ▶ Place the next tile in position, alternating the direction (tessellation) of marbling or colour, and proceed down the centreline, laying two tiles wide i.e. one tile either side of the centreline.
  - ▶ It is essential to keep the tiles exactly on the centreline.
  - ▶ **When using 'high tack' adhesives such as pressure sensitive adhesive, take care not to twist or distort the tile whilst laying. If a tile is stretched, dimensional stability will eventually return the tile back to its original shape and the adhesive bond will be broken.**

- ▶ Repeat the sequence along the centreline, at right angles to the first. Then, working from the completed centrelines, finish the section, taking care that tile bond is maintained throughout. Alternatively the pyramid layout can be followed (refer to figure 4.10, page 42).
- ▶ Any excess adhesive should be removed as work proceeds.
- ▶ When a section has been laid, except for the perimeter, it should be thoroughly rolled in both directions with a 68kg articulated floor roller.
- ▶ Repeat for each section until the main field of tiles has been laid.

#### 4.8 CUTTING THE PERIMETER TILES (STRAIGHT LAID)

Two techniques are commonly used for cutting perimeter tiles. The choice is mainly dependent upon the run out of the wall.

##### 4.8.1 Overlapping Method (Straight Laid)

Used when there is little or no run out of the abutting wall.

- ▶ Place the tile to be cut exactly over the last tile laid, ensuring the colour is correct and the decoration runs the correct way.
- ▶ Place another full tile on top of the tile to be cut with its 'top edge' against the wall or set-in coved skirting (refer to figure 4.5).



Figure 4.5 Measuring using an overlapping tile

- ▶ Scribe a line onto the tile to be cut, using the 'bottom edge' of the top tile as a guide.
- ▶ Cut the tile to the scribed line, loose lay into position and check the fit. Repeat along the whole wall.

##### 4.8.2 Scriber Method (Straight Laid)

Used when the wall run out is quite severe or when the wall profile cannot be picked up using a straight edge.

- ▶ Place the tile to be cut exactly over the last tile laid, ensuring the colour is correct and the decoration runs the correct way.
- ▶ Set the bar scriber to the size of tile being laid.



- ▶ Trace the profile of the wall onto the tile to be cut, ensuring the bar scriber is kept upright and square to the edge of the tile.



Figure 4.6 Measuring a tile using a scriber

- ▶ Cut the tile to the scribed line, loose lay into position and check the fit. Repeat along the whole wall.

#### 4.9 CUTTING THE PERIMETER TILES (DIAGONAL CUT)

Three techniques are commonly used for cutting perimeter tiles. The choice mainly depends upon the run out of the wall.

Both the Overlapping and Scriber Methods can be used to fit around projections such as door frames. Similarly, a template can be made or a profile gauge containing movable pins used for awkward shapes.

##### 4.9.1 Overlapping Method (Diagonal Cut)

Used when there is little or no run out of the abutting wall.

- ▶ Place the tile to be cut exactly over the last tile laid, ensuring the colour is correct and the decoration runs the correct way.
- ▶ Place another full tile on top of the tile to be cut (diagonally) with the 'top edge' against the wall or set-in coving (figure 4.7).



Figure 4.7 Marking the perimeter tiles (diagonal cut)

- ▶ The corresponding point of the tile should then be followed to mark the underlying tile.
- ▶ The overlapping tile should then be moved over to mark the second part of the underlying tile.
- ▶ Following both marks, a straight edge can be used to line both marks and a cut can be made.
- ▶ Cut the tile to the scribed line, loose lay into position and check the fit. Repeat along the whole wall.

##### 4.9.2 Template overlapping method (Diagonal Cut)

- ▶ Cut a template exactly to the size between the diagonal points (e.g. 423mm for 300mm tiles).
- ▶ Place the tile to be cut exactly over the last tile laid, ensuring the colour is correct and the decoration runs the correct way (refer to figure 4.8).
- ▶ Place the template tile on top of the tile to be cut with its 'top edge' against the wall.
- ▶ Scribe a line onto the tile to be cut, using the 'bottom edge' of the tile as a guide.



Figure 4.8 Cutting the perimeter tiles (diagonal cut)

- ▶ Cut the tile to the scribed line, loose lay into position and check the fit. Repeat along the whole wall.

##### 4.9.3 Scriber method (Diagonal Cut)

Used when the wall run out is quite severe or when the wall profile cannot be picked up using a straight edge.

- ▶ Place the tile to be cut exactly over the last tile laid, ensuring the colour is correct and the decoration runs the correct way.
- ▶ Set the bar scriber to the size of tile between the diagonal points of tile being laid.

- ▶ Trace the profile of the wall onto the tile to be cut, ensuring the bar scriber is kept flat to the floor and square to the edge of the tile.



Figure 4.9 Cutting the tiles using a scriber (diagonal cut)

- ▶ Cut the tile to the scribed line, loose lay into position and check the fit. Repeat along the whole wall.

#### 4.9.4 Adhering the Perimeter Tiles

Once a wall edge has been fitted and loose laid, turn all the tiles inward so as not to lose their position.

- ▶ Spread the adhesive right up to the edges. When the adhesive is ready, lay the perimeter tiles.
- ▶ Wipe up excess adhesive as work progresses.
- ▶ Roll well with a 68kg articulated roller. Use a small hand roller in areas that are inaccessible.
- ▶ Repeat the process for all four walls.
- ▶ Finally, the whole floor should be given a second rolling, approximately one to four hours later.

#### 4.10 INSTALLING TILES IN LARGE AREAS

Maintaining a clearly defined straight line over long distances can be difficult and often leads to inaccuracies. To eliminate this problem, an alternative technique is used when laying tiles in large areas:

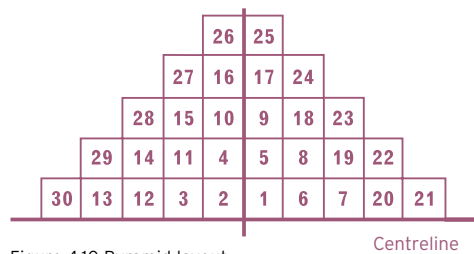

Figure 4.10 Pyramid layout

#### KEY POINT

Construction of a pyramid should always start at the centre of the baseline, working in the same sequence as shown in Figure 4.10

- ▶ Establish the central starting point, as described previously, minimising small cuts on perimeter tiles.
- ▶ Lay the first pyramid of tiles from the centrelines, using the sequence shown in figure 4.10. Ensure a close bond is maintained at all times.
- ▶ Repeat this sequence on the opposite side of the centreline shown as area 2 in figure 4.11. Continue working in larger and larger pyramids, as shown in figure 4.11, until only the perimeter tiles require fitting.
- ▶ Fit the perimeter tiles as described in Section 4.8.

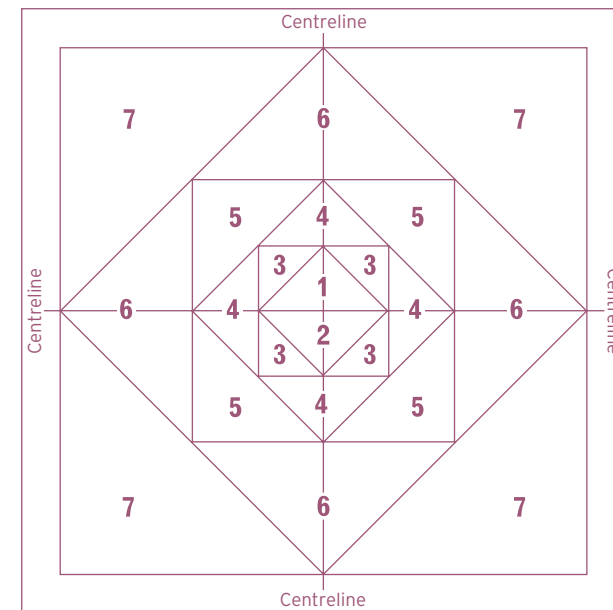

Figure 4.11 Continue working in larger pyramids

#### 4.11 ADHESIVES

The use of the correct adhesive is essential for a successful installation.



Figure 4.10 Selection of the correct adhesive is essential

Types & Suitability of adhesive are covered on 3 & 4 day Polyflor Floor Laying Courses

Polyflor provide a comprehensive approved adhesive list available at [polyflor.com](http://polyflor.com) or by contacting the **Polyflor Customer Technical Services Department (CTSD)**.

In areas subjected to direct sunlight or extremes/fluctuations in temperatures Polyflor always recommend the use of an approved polyurethane; epoxy or suitable high temperature adhesive. Polyflor provide this information only as guidance and the legal responsibility for the supply and performance is that of the adhesive manufacturer.

#### 4.12 WELDING OF VINYL TILES

Polyflor recommend that all 608mm tile installations be heat welded. The use of a contrasting weld rod can be used to create simple design effects. To calculate how much weld rod is required for the installation, multiply the number of square metres laid by 3.3, to give you the number of linear metres of weld rod.



Further information on heat welding can be found in Section nine.





# INSTALLATION OF LUXURY VINYL TILES

The installation of luxury vinyl tiles and planks.

## 5.1 RECEIPT & STORAGE

On receipt of tiles and/or planks:

- ▶ Check that colours correspond to those ordered, that quantities are correct and there is no damage.
- ▶ In particular, check that tiles/planks are from one batch, if that was requested on the order.
- ▶ On arrival at site, the tiles should be stored indoors, together with the adhesive, at a consistent temperature of between 18°C and 27°C for at least 24 hours prior to laying.
- ▶ Following off-loading, boxes should be stacked no more than five high during the conditioning period. The boxes should be opened and conditioned in the area where they are to be installed.
- ▶ For Design Floors, identify and check each element before work proceeds.
- ▶ To achieve best results, site conditions should be prepared as described in BS 8203 or prevailing local or national standards. A working temperature of between 18°C and 27°C is required for at least 48 hours prior to, and during, the installation period; and for 24 hours afterwards. Conditioning should be carried out in the same room or area as the installation, to prevent thermally induced dimensional changes.

## 5.2 PRIOR TO INSTALLATION (UNDERFLOOR HEATING)

On installations where underfloor heating is used:

- ▶ The system should be fully tested and commissioned prior to the flooring installation commencing.
- ▶ Underfloor Heating systems should be switched off and be fully cooled for a minimum of 48 hours prior to the installation commencing. The system should remain off and fully cooled during the installation and for a minimum of 48 hours afterwards. It should then be slowly brought back up to the working temperature incrementally over several days.
- ▶ A maximum subfloor temperature; (at the adhesive line) of 27°C should never be exceeded.
- ▶ Only specialist high temperature or epoxy adhesives should be used in areas with underfloor heating, direct sunlight, and areas of high solar gain. Please refer to the Polyflor Approved Adhesive List or contact your adhesive manufacturer for more information.

## 5.3 PREPARATION FOR INSTALLATION

The decoration of tiles is randomly distributed and can be heavier on some tiles than others. To prevent 'heavy' and 'light' areas, the tiles should be unboxed and, if required, 'shuffled'. Alternating the direction of tiles may be required to avoid repeat patterns.



## 5.4 PRODUCT CONDITIONING

The majority of installation failures are not caused by poor fitting but instead simply by failure to condition the vinyl tiles and planks correctly prior to installation.

- ▶ The tiles and planks plus any other products such as borders, feature strips, design strips, tozzettos and adhesives and new plywood bases; should be conditioned together for at least 24 hours prior to installation.
- ▶ Boxes of tiles/planks must be stacked less than 5 boxes high and planks/tiles removed 30 minutes before use.
- ▶ The room temperature should ideally be between 18°C and 27°C but more importantly should be constant and not varying by more than 2°C.
- ▶ Conditioning should ALWAYS take place in the area that is to receive the installation.
- ▶ The conditioning time should be increased to at least 48 hours where the planks/tiles have been stored and /or delivered at temperatures below 10°C.
- ▶ As extremes of temperature can occur between day and night time, temperatures will fluctuate. It is essential that the effects of these fluctuations be avoided.
- ▶ South facing and full height windows; (Inc. patio & bi-fold doors) and all conservatory windows should be shaded or covered both during the conditioning period; the installation period; and for 24 hours after the installation has been completed to minimise this effect.

**NOTE** Complaints arising from the failure to correctly condition the tiles and planks, which result in shrinkage or lipping, will not be accepted by Polyflor Ltd.



Further information on operating temperatures can be found in section thirteen .

## 5.5 PREPARATION OF THE WORK AREA

### KEY POINT

Commencement of work is deemed by many as acceptance of the site conditions as suitable for laying floor coverings.

The work area should now be prepared to receive the tiles.

- ▶ Ensure that all other trades have completed their work and removed all their equipment and materials.
- ▶ Remove all debris and vacuum the whole subfloor area. Check the condition of the subfloor and make good as necessary.
- ▶ Stone or power grind any cementitious subfloor to remove any 'nibs' or ridges. Remove any surface contaminants that may affect adhesion.

- ▶ Sweep or vacuum again prior to laying.
- ▶ If required by the contract, or if in doubt, check the moisture content of the subfloor and record the results and method used.
- ▶ Good lighting is essential.



Further information on subfloors and subfloor preparations can be found in Section two.

## 5.6 SETTING OUT AND INSTALLATION FOR TILES/PLANKS STRAIGHT FITTING

The optimum appearance can be produced by carefully planning and setting out of tiles and/or planks.

- ▶ It is advantageous to dry lay a section of the floor so that it can be determined whether the appearance of the pattern is acceptable and also to ensure any graining/texture within individual tiles is correct.
- ▶ Traditionally the starting point for tiling is the centre of the room.



Figure 5.1 Setting planks out

- ▶ Before adhering confirm that the overall appearance of the flooring is acceptable.
- ▶ If the room is irregular in shape it may be necessary to square up the tiles off the most important wall or a specific feature.

### 5.6.1 To set out Planks for straight fitting:

- ▶ Prior to laying the first plank, ensure all cuts are of an acceptable length (Min. 150mm).
- ▶ As the planks are not required to be laid 'in bond' in the length, it is possible to begin installing from an end wall.
- ▶ Planks must be staggered to obtain a random finish, however ensure that plank ends are not within 150mm of adjacent planks.

5.6.2 Setting out and installation for straight tiling (Refer to Figure 5.2)

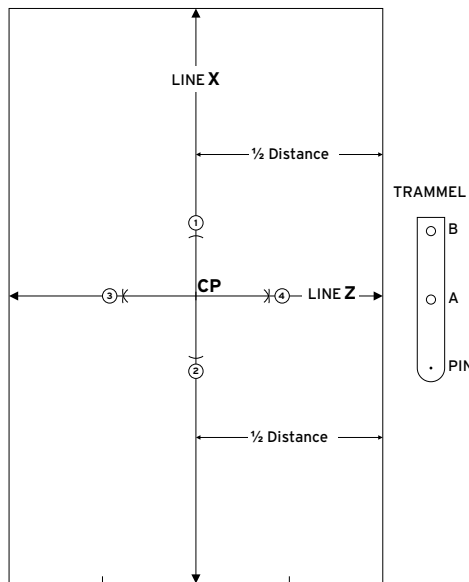

Figure 5.2

- ▶ Measure the room to be laid, in both directions, including any alcoves etc.
- ▶ Mark a centre line X. Ensure it is central to the room dimensions.
- ▶ Loose lay tiles to ensure there are no small cuts at the perimeter. If small strips are evident, move the centre line across half a tile in either direction to create an acceptable sized cut.
- ▶ Find the centre of line X and mark the Centre Point (CP).
- ▶ Mark arcs 1 & 2 at equal distances from CP on the centre line using point A on your trammel.
- ▶ With points 1 & 2 as centres, use point B on your trammel to draw further arcs intersecting at 3 & 4.
- ▶ Strike a line through point 3 & 4 ensuring it passes through CP.
- ▶ Line Z is now 90° to line X. Double check using the 3,4,5 method.

5.6.3 Setting out and installation for diagonal tiling (Refer to Figure 5.3)

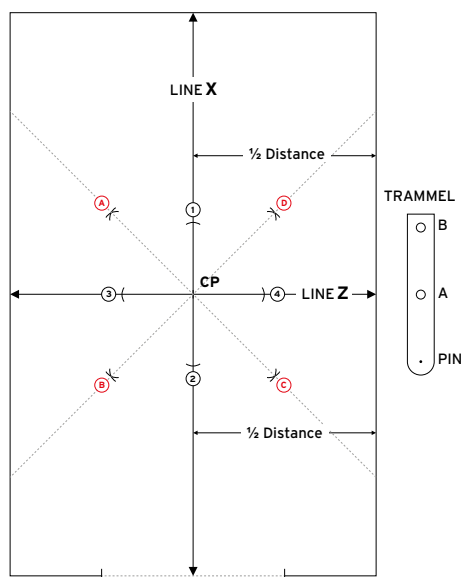

Figure 5.3

- ▶ Set out as overleaf for straight tiling. Ensure both lines are at 90° to each other.
- ▶ At CP (Centre Point), use point B on your trammel to mark arcs at 1, 2, 3 and 4.
- ▶ With points 1 & 3 as centres using point B on your trammel draw arcs to intersect each other at A.
- ▶ With points 2 & 4 as centres using point B on your trammel draw arcs to intersect each other at C.
- ▶ Strike a chalk line from wall to wall through points A & C; if no error has been made, this line will pass through CP.
- ▶ With points 1 & 4 as centres using point B on your trammel draw arcs to intersect each other at D.
- ▶ With points 2 & 3 as centres using point B on your trammel draw arcs to intersect each other at B.
- ▶ Strike a chalk line from wall to wall through points B & D; if accurate, this line should pass through CP. Double check using the 3,4,5 method.

5.7 SPREADING THE ADHESIVE

- ▶ Once the start point has been established, depending on the size of the area and the type of adhesive to be used, it may be necessary to section off the area so that the adhesive can be applied to areas that can be laid within the open time.
- ▶ Always follow closely the approved adhesive manufacturer's instructions.
- ▶ Spread the adhesive using a suitable trowel to the manufacturer's recommendations ensuring that the correct notch size is maintained throughout the installation. If the notch on the trowel shows signs of wear it should be renewed immediately.
- ▶ If using a Polyflor approved pressure sensitive adhesive it may be necessary to flatten out any resultant serrated adhesive ridges using a lambswool roller pre-wetted with adhesive to prevent 'grin through' once the installation has been completed.
- ▶ Always read carefully the adhesive manufacturer's application instructions as these can change from brand to brand. NB: This can be especially important when planks/tiles are being bonded to an absorbent substrate such as sand and cement screeds; plywood etc. in order to ensure an adequate bond strength.
- ▶ When a section has been laid, except for the perimeter, it should be thoroughly rolled in both directions with a 68kg articulated floor roller. Repeat for each section until the main field of tiles has been laid.
- ▶ It is advantageous to leave the last full tile or plank and the cut at the perimeter without adhesive until all planks have been cut to size.

5.8 SETTING OUT AND INSTALLATION OF BORDERS

The inclusion of borders or design strips is a simple way of enhancing the appearance of an installation. Borders and design strips come in various widths and styles but the installation technique is similar in all cases. Borders fit around the field tiles but do not attempt to abut pre-made borders to a wall.

Most designs will have a contrasting yet complimentary border. It is preferred, where possible, that full tiles are fitted up to the borders, in the case of diagonal, exactly half tiles should be used. This gives a more geometric appearance to the installation. It does, however, mean that, in almost all cases the border will have to be adjusted on adjacent walls.

In the case of diagonal tiles and for the sake of appearance, the colour of the cut half field tile should contrast with the border.

- ▶ Mark a centre line as described earlier (figure 5.3).

- ▶ Determine width of borders.
- ▶ Dry tile to ensure cuts are acceptable and of the correct colour and adjust where necessary.
- ▶ Using centre lines as guides measure to the position of the border and mark with chalk lines.
- ▶ Spread adhesive up to the border lines and fit field tiles. (Remember only spread adhesive to areas that can be laid within the open time).
- ▶ Dry fit perimeter cuts before adhering, as described earlier.

**NOTE** This is the normal method of setting out for borders, however it is also possible to set out off a prominent wall or unit, for example. If there is any doubt the border should be discussed with the end user prior to installation.

### 5.9 INSTALLING IN LARGE AREAS

Maintaining a clearly defined straight line over long distances can be difficult and often leads to inaccuracies. To eliminate this problem, an alternative technique is used when laying in large areas.

- ▶ Establish the central starting point as described previously, minimising small cuts on perimeter tiles.
- ▶ Lay the first pyramid of tiles from the centre lines, using the sequence shown. Ensure a close bond is maintained at all times (figure 5.4).
- ▶ Repeat this sequence on the opposite side of the centre line. Continue working in larger and larger pyramids until only the perimeter tiles require fitting (figure 5.5).
- ▶ Fit perimeter tiles as described in section 5.10, page 53.

**KEY POINT**  
Construction of a pyramid should always start at the centre of the baseline, working in the same sequence as shown in Figure 5.4

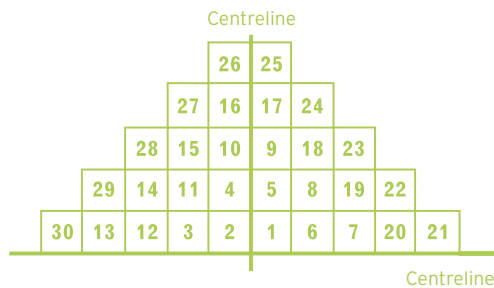
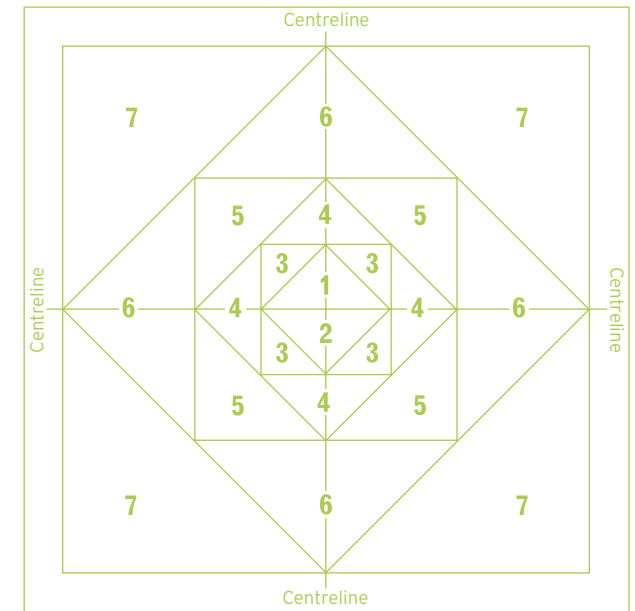

Figure 5.4 Pyramid layout

Figure 5.5 Floor layout



### 5.10 INSTALLATION OF PERIMETER TILES/PLANKS (STRAIGHT LAID)

#### 5.10.1 Cutting the perimeter tiles/planks (Straight Laid)

To avoid run out of the bond, cutting of perimeter row should start at the centre of the wall and work out towards corners. The choice of technique used for cutting perimeter tiles/planks is largely dependent upon the straightness of the wall.

#### 5.10.2 Overlapping Method (Straight Laid)

Used when there is little or no run out of the abutting wall.



Figure 5.6 Measuring using an overlapping tile

- ▶ Place the tile to be cut exactly over the last tile laid, ensuring the colour is correct and the decoration runs the correct way.

- ▶ Place another full tile on top of the tile to be cut with its 'top edge' against the wall or skirting/base board.
- ▶ Scribe a line onto the tile to be cut, using the 'bottom edge' of the top tile as a guide.
- ▶ Cut the tile to the scribed line, loose lay into position and check the fit. Repeat along the whole wall.

### 5.10.3 Scriber Method (Straight Laid)

Used when the wall run out is quite severe or when the wall profile cannot be picked up using a straight edge.



Figure 5.7 Scribing a line

- ▶ Place the tile to be cut exactly over the last tile laid, ensuring the colour is correct and the decoration runs the correct way.
- ▶ Set the bar scriber to the size of tile being laid.
- ▶ Trace the profile of the wall onto the tile to be cut, ensuring the bar scriber is kept flat to the floor and square to the edge of the tile.
- ▶ Cut the tile to the scribed line, loose lay into position and check the fit. Repeat along the whole wall.

## 5.11 CUTTING THE PERIMETER TILES (DIAGONAL CUT)

### 5.11.1 Overlapping Method (Diagonal Cut)

Used when there is little or no run out of the abutting wall.

- ▶ Place the tile to be cut exactly over the last tile laid, ensuring the colour is correct and the decoration runs the correct way.
- ▶ Place another full tile on top of the tile to be cut (diagonally) with the 'top edge' against the wall or set-in coving (figure 5.8).
- ▶ The corresponding point of the tile should then be followed to mark the underlying tile.
- ▶ The overlapping tile should then be moved over to mark the second part of the underlying tile.



Figure 5.8 Marking using an overlapping template on diagonal laid tiles

- ▶ Following both marks, a straight edge can be used to line both marks and a cut can be made.
- ▶ Cut the tile to the scribed line, loose lay into position and check the fit. Repeat along the whole wall.

### 5.11.2 Template overlapping method (Diagonal Cut)

- ▶ Cut a template exactly to the size between the diagonal points (e.g. 428mm for 305mm tiles).
- ▶ Place the tile to be cut exactly over the last tile laid, ensuring the colour is correct and the decoration runs the correct way (refer to figure 5.9).
- ▶ Place the template tile on top of the tile to be cut with its 'top edge' against the wall.
- ▶ Scribe a line onto the tile to be cut, using the 'bottom edge' of the tile as a guide.
- ▶ Cut the tile to the scribed line, loose lay into position and check the fit. Repeat along the whole wall.



Figure 5.9 Cutting the perimeter tiles (diagonal cut)

Gain an in-depth knowledge of Installation of LVT on the 2 day Polyflor LVT Courses



### 5.11.3 Scriber Method (Diagonal Cut)

Used when the wall run out is quite severe or when the wall profile cannot be picked up using a straight edge.

- ▶ Place the tile to be cut exactly over the last tile laid, ensuring the colour is correct and the decoration runs the correct way.
- ▶ Set the bar scriber to the size of tile between the diagonal points of tile being laid.
- ▶ Trace the profile of the wall onto the tile to be cut, ensuring the bar scriber is kept flat to the floor and square to the edge of the tile.



Figure 4.9 Cutting the tiles using a scriber (diagonal cut)

- ▶ Cut the tile to the scribed line, loose lay into position and check the fit. Repeat along the whole wall.

### 5.12 ADHERING THE PERIMETER TILES

- ▶ Once a wall edge has been fitted and loose laid, turn all the tiles inward so as not to lose their position.
- ▶ Spread the adhesive right up to the edges. When the adhesive is ready, lay the perimeter tiles.
- ▶ Wipe up excess adhesive as work progresses.
- ▶ Roll well with a 68kg articulated roller. Use a small hand roller in areas that are inaccessible.
- ▶ Repeat the process for all four walls.
- ▶ Finally, the whole floor should be given a second rolling, approximately one to four hours later.

### 5.13 ADHESIVES

In areas subjected to direct sunlight or extremes/fluctuations in temperatures Polyflor always recommend the use of an approved polyurethane; epoxy or suitable high temperature adhesive. Polyflor provide this information only as guidance and the legal responsibility for the supply and performance is that of the adhesive manufacturer.

Use of the correct adhesives is important if the installation is to be successful. Polyflor provide a comprehensive approved adhesive list available at polyflor.com or by contacting the **Polyflor Customer Technical Services Department (CTSD)**.

### 5.14 INLAY STRIP CALCULATION

Developed to add fine detailing to an overall floor covering, inlay strips include Grouting Strips, Marquetry Strips, Cross Grain Marquetry Strips and Feature Strips.

Due to the extensive range of Tile and Planks sizes currently available in the Polyflor ranges we recommend that you call **Polyflor CTSD** for advice regarding Inlay Strip Calculation on +44 (0) 161 767 1912.

### 5.15 TILE AND PLANK FLOOR DESIGNS

Decorative Design Floors like design 3, 4, 6 and 7 can be achieved quite simply on site with little or no cutting required whilst more ambitious and sophisticated designs like designs 1, 2 and 5 can be created with the help of Polyflor's bespoke cutting service.

These diagrams represent only a small selection of flooring designs possible with Luxury Vinyl Tiles, discover more ideas and designs in the product brochures.



Design 1

Herringbone Design (typically third length planks)

CAMARO  
2202 Nut Tree

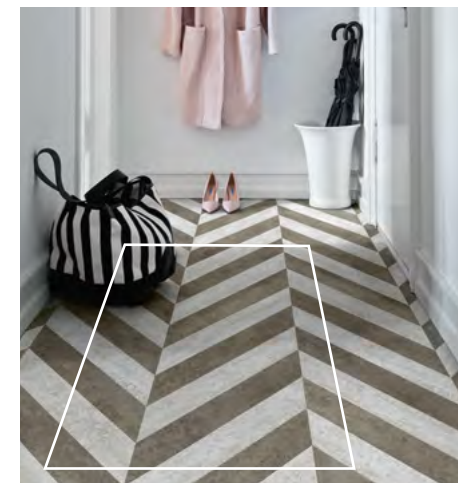
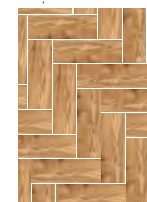

Design 2

Off-set chevron cut tiles

CAMARO  
2345 Glacier Slate  
2346 Highland Slate





**Design 3**  
Full Plank Herringbone



**EXPONA COMMERCIAL**  
4063 Grey Pine



**Design 4**  
Double Plank Tramline

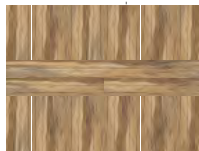

**EXPONA COMMERCIAL**  
4102 Wild Teak



**Design 5**  
Off-set keysquare design  
with strip

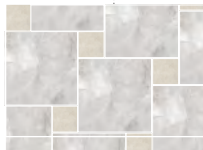

**CAMARO**  
2341 Arctic Slate  
2332 White Metalstone



**Design 6**  
Brickwork Layout



**EXPONA COMMERCIAL**  
5058 Dovetail Slate  
0037 Beige Grouting Strip

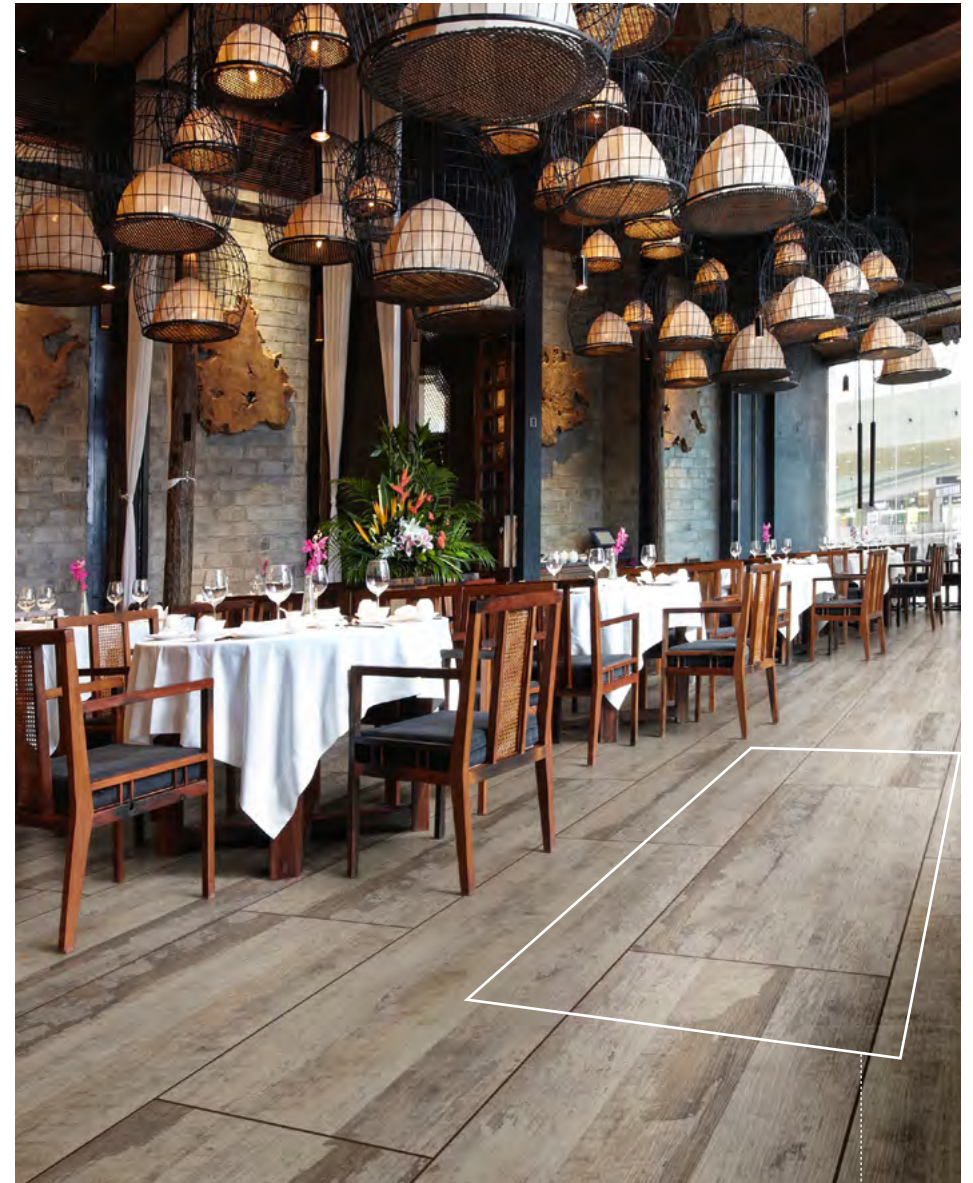

**Design 7**  
Brickwork Wood Tile Effect



**EXPONA COMMERCIAL**  
4107 Natural Barnwood  
5110 Brown feature Strip



# INSTALLATION OF LOOSE LAY VINYL

The installation of:

## 6.1 LOOSE LAY VINYL SHEET

## 6.12 LOOSE LAY VINYL TILES & PLANKS

## 6.21 INTERLOCKING TILE & PLANK SYSTEMS

## 6.1 LOOSE LAY VINYL SHEET

### 6.2 RECEIPT & STORAGE

- ▶ On receipt of rolls, check that colour references correspond to those ordered, that quantities are correct and that there is no damage.
- ▶ In particular, check that rolls are from one batch, if that was requested on the order.
- ▶ On arrival at site, the rolls should be safely secured, positioned and stored in accordance with the directions on the roll label at a minimum temperature of 18°C for at least 48 hours prior to installation.
- ▶ To achieve best results, site conditions should be as described in BS 8203 or prevailing local/national standards. A constant working temperature between 18°C and 27°C should be maintained for at least 48 hours prior to installation, during the installation and for 48 hours afterwards.

### 6.3 LOOSE LAY CONDITIONING

- ▶ Polyflor Loose Lay Vinyl sheet requires conditioning ahead of installation. Conditioning should be carried out in the same areas as the installation, to prevent thermally induced dimensional changes.
- ▶ Conditioning should ALWAYS take place in the area that is to receive the installation.
- ▶ The conditioning time should be increased to at least 48 hours where the sheet has been stored outside or stored/delivered at temperatures below 10°C.

### 6.4 PRIOR TO INSTALLATION (UNDERFLOOR HEATING)

On installations where underfloor heating is used:

- ▶ The system should be fully tested and commissioned prior to the flooring installation commencing.
- ▶ Underfloor Heating systems should be switched off and be fully cooled for a minimum of 48 hours prior to the installation commencing. The system should remain off and fully cooled during the installation and for a minimum of 48 hours afterwards. Then slowly bring back up to the working temperature incrementally over several days.
- ▶ A maximum subfloor temperature of 27°C should never be exceeded.

### 6.5 PREPARATION OF WORK AREA

- ▶ The work area should now be prepared to receive the sheet flooring. Ensure that all other trades have completed their work and removed all their equipment and materials.

**KEY POINT**

Commencement of work is deemed by many as acceptance of the site conditions as suitable for laying floor coverings.

- ▶ Remove all debris and sweep or vacuum the whole floor area. Check the condition of the subfloor and make good as necessary.
- ▶ Stone or power grind any cementitious subfloor to remove any 'nibs' or ridges.
- ▶ Sweep or vacuum again prior to laying.
- ▶ If required by the contract, or if in doubt, check the moisture content of the subfloor and record the results and method used.
- ▶ Good lighting is essential.

**6.6 LAYOUT OF LOOSE LAY VINYL SHEET**

- ▶ The architect may have provided a drawing showing the direction in which the material should be laid. In this case, lay the sheet as directed.
- ▶ On installations where the architect has left this to the discretion of the flooring contractor; at the tender stage show in which direction the material will be laid and state that your estimate is based on this.
- ▶ If a joint is necessary always pay particular attention to where seams will fall, avoiding such occurrences as seams in the centre of doorways. If large windows are installed, minimise the effect of the joints by laying towards the window.
- ▶ For large areas over 20m<sup>2</sup> where a joint will be necessary or where rolling loads are likely, Polyflor recommend that the vinyl is fully bonded to the subfloor with a recommended adhesive from the Polyflor Approved Adhesive list.



Further information on fully bonded installation instructions can be found in Section three.

**6.7 SLABBING THE SHEET**

- ▶ Polyflor recommends that all Polyflor sheet flooring be rolled out face upward, taking care not to damage the surface, and cut approximately to size.
- ▶ Allowance of at least 75mm should be made at the ends for trimming in, the slabs should then be left overnight for 24 hours, to condition at a consistent temperature range between 18°C and 27°C.

**6.8 FITTING THE FIRST LENGTH**

- ▶ Place the first sheet in position next to the wall with the outer edge approximately 15mm from the nearest point.
- ▶ Adjust the lie of the sheet so that the inner edge is parallel with the axis of the room (Figure 6.1).

**KEY POINT**

A 2mm gap must be allowed around the perimeter of the room

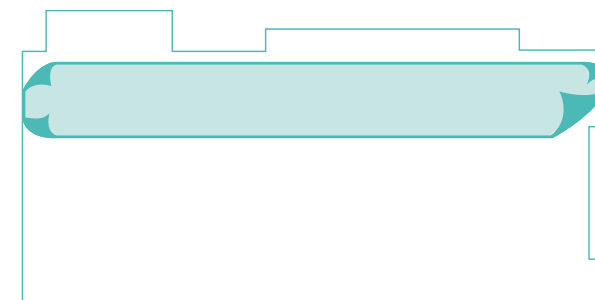

Figure 6.1 Lining up the first sheet

- ▶ Depending upon the depth of the recesses, either a bar scriber or a pair of scribers should be used to trace the profile of the wall. The scribers should be set to allow for the deepest recess or rake of the wall. The scribers should be set to allow for a 2mm expansion gap around the perimeter.
- ▶ Holding the scribers vertically and square to the edge, trace the wall profile onto the face of the sheet (Figure 6.2).

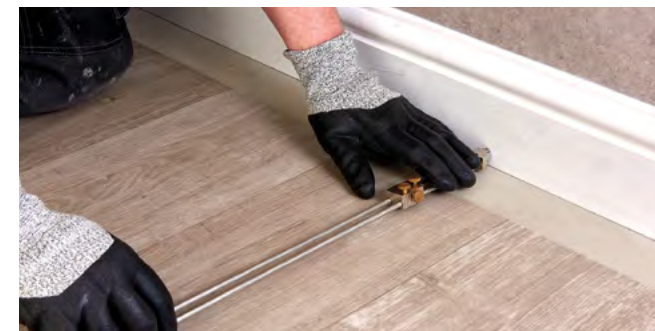

Figure 6.2 Scribing the wall profile

- ▶ Care should be taken when using the wider widths of loose lay sheet (3m or 4m) not to fully fold the sheet over itself when fitting into recesses and against walls as this can lead to pressure marks that might not relax out following installation.
- ▶ With this method, all irregularities of the wall will be accurately reproduced onto the surface of the sheet. If, because of the colour or decoration, the scribed line is difficult to see, rub suitably contrasting chalk dust into the line to highlight it.
- ▶ Ease the sheet away from the wall and, using a hook blade trimming knife, cut off the excess material to the scribed line.
- ▶ Slide the sheet back against the wall and check the fit, making any minor adjustments as necessary.



- ▶ When satisfied that the fit on the first edge is correct, use a pencil to trace the opposite edge onto the subfloor (line A-B in Figure 6.3).
- ▶ In the centre of the room, draw a line on both the sheet and subfloor square to the main axis of the sheet (line C-D in Figure 6.3).
- ▶ Keeping the inner edge of the sheet on line A-B, slide the sheet back to clear the wall at one end of the room.

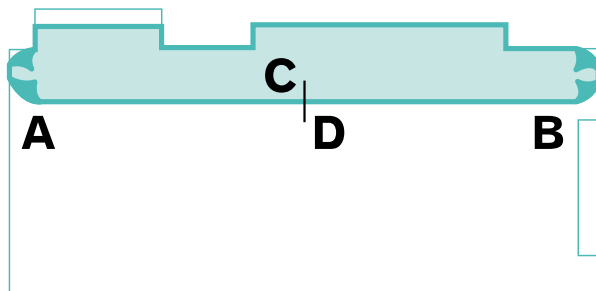

Figure 6.3 Marking the position

- ▶ Set the scribers to the distance now between lines C and D (Figure 6.4) allowing for a 2mm expansion gap.
- ▶ Trace the end wall profile and cut to fit as described in preceding paragraphs. Repeat for the other end of the sheet.



Figure 6.4 Scribing the wall profile

## 6.9 FITTING SUBSEQUENT LENGTHS

### 6.9.1 Alignment of decoration

- ▶ This type of floor covering features a print layer with a regular, repeat decoration (e.g. wood plank). It is important that care is taken to align the pattern decoration of each adjacent sheet.  
If in any doubt contact the [Polyflor Customer Technical Services Department \(CTSD\)](#) for further advice on +44 (0) 161 767 1912.

- ▶ The label and printed information on the backing of the sheet must be checked and the product reverse laid when instructed.

## 6.10 CUTTING IN THE SEAMS

Polyflor recommends that all vinyl sheet floor coverings are welded.

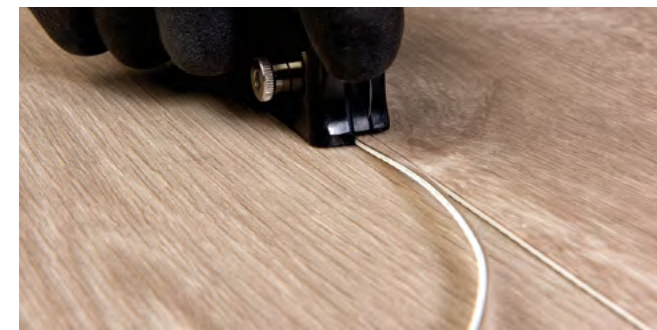

Figure 6.5 Cutting in the seams



Further information on seam cutting and cold welding can be found in Section nine.

## 6.11 PATTERN TEMPLATE METHOD

### NEW BUILDINGS

Consider coming to an agreement with the main contractor to fit fixtures such as WCs & sinks after the vinyl has been laid.

Areas which call for a considerable amount of fitting around obstacles, or which are too confined to lay down a sheet for fitting by normal methods, can be dealt with by templating the floor in felt paper.

- ▶ Dry fit the area with felt paper, leaving a gap of 15mm to 20mm around obstructions and walls.
- ▶ Draw around the fittings using a compass set at 25mm. Mark the template 'This Side Up'.
- ▶ Place the sheet in a larger area with the face uppermost.
- ▶ Place the template on top ensuring the direction of decoration on the sheet is correct.
- ▶ Secure the template firmly in position and, with a pair of scribers set at 25mm, mark the position of all obstacles using the template as a guide.
- ▶ Using a sharp trimming knife, cut the sheet to the scribed lines and fit into position.

**NOTE** Do not use the felt paper template as an underlay.

## 6.12 LOOSE LAY VINYL TILE AND PLANK

### 6.13 RECEIPT & STORAGE

On receipt of tiles or planks:

- ▶ Check that colours correspond to those ordered, that quantities are correct and there is no obvious damage.
- ▶ In particular, check that tiles are from one batch, if that was requested on the order.
- ▶ On arrival at site, the tiles should be stored, together with the adhesive, at a minimum temperature of 18°C for at least 48 hours prior to laying.
- ▶ Under normal conditions (outside temperature above 10°C) the tiles should be off-loaded from the pallet and stacked no more than **five** boxes high during the conditioning period. The stacks should be arranged to allow the air to circulate around the stack on all sides.
- ▶ In cold weather (outside temperature below 10°C) the boxes should be opened and the tiles spread out in the area where they are to be installed permitting the tiles to acclimatize more quickly.
- ▶ To achieve best results, site conditions should be as described in BS 8203 or prevailing local/national standards. A working temperature of between 18°C and 27°C is required for 48 hours prior to, and during the laying period and for 48 hours afterwards.

### 6.14 LOOSE LAY CONDITIONING

The temperature should be constant and not vary more than 2°C. Conditioning areas and laying areas should be of similar temperature, to prevent thermally induced dimensional changes.

### 6.15 PRIOR TO INSTALLATION (UNDERFLOOR HEATING)

- ▶ On installations where underfloor heating is used, the system should be fully tested and commissioned prior to the flooring installation commencing.
- ▶ Underfloor Heating systems should be switched off and be fully cooled for a minimum of 48 hours prior to the installation commencing.
- ▶ The system should remain off and fully cooled during the installation and for a minimum of 48 hours afterwards. It should then be slowly brought back up to the working temperature incrementally over several days. A maximum floor temperature of 27°C should never be exceeded.

## 6.16 PREPARATION OF WORK AREA

The work area should now be prepared to receive the vinyl tiles.

- ▶ Ensure all other trades have completed their work and removed all their equipment and materials.
- ▶ Remove all debris and sweep or vacuum the whole floor area.
- ▶ Check the condition of the subfloor and make good as necessary.
- ▶ Commencement of work is deemed by many as acceptance of the site conditions as suitable for laying floor coverings.

## 6.17 LAYOUT OF LOOSE LAY VINYL TILES

Although many floor layers regard vinyl tiles as being easier to lay than vinyl sheet, the layout of the tiles can be critical to the success of the installation. The regular form of tiles, especially when laid in contrasting colours, can accentuate deviations in the building line, emphasizing the need for detailed planning of the layout.

Many floor layers start in the main doorway, believing that the initial impression when entering a room is most important. However, working from the centre of the room and loose laying tiles to check the layout will make the final appearance correct from any viewpoint. This is of particular importance when incorporating a geometric design into a floor.

- ▶ Cut with a sharp knife from the face side, ensuring the cut is 90°, by scoring twice, the 2nd score cuts the glass fibre reinforcement layer. Open up the cut by bending the tile, and then finish the cut from the back side.
- ▶ A minimum 2mm expansion gap must be left between the product and the wall or other fixed components such as door frames or heating pipes.
- ▶ When installing in an entrance area; larger-scale heavy commercial environments or any areas where heavy foot traffic or regular rolling loads can be expected, a suitable double sided contact tape or suitable tackifier release system, can be used to avoid movement. If tape is used it should be applied diagonally, running one way only, across the full area at 500mm centres. This will ensure that all tiles are secured to the substrate.
- ▶ Areas larger than 10m x 10m, require the inclusion of a 5mm expansion joint. A suitable expansion joint cover should be used. Expansion joints should be included for every subsequent 100m<sup>2</sup>.

Find out more about the **Layout of Loose Lay** on the **4 day Polyflor Floor Laying Course**

- ▶ As extremes of temperature can occur between day and night time, temperatures will fluctuate. It is essential that the effects of these fluctuations be avoided. Installations that are directly adjacent to south facing and full height windows should be covered both during the conditioning and installation periods to minimise this effect. This includes covering patio doors, bi-fold doors and conservatory or orangery windows. Complaints arising from the failure to correctly condition the tiles and planks, which result in shrinkage or lipping, will not be accepted by Polyflor Ltd.

### 6.18 MEASURING AND MARKING OUT

#### KEY POINT

When setting out planks/tiles, always start from the centre of the room

- ▶ In order to produce the optimum appearance carefully plan and set out the tiles. It is advantageous to dry lay a section of the floor so that it can be determined whether the appearance of the pattern is acceptable and also to ensure any graining/texture within individual tiles is correct.
- ▶ Traditionally the starting point for tiles is the centre of the room.
- ▶ Before adhering confirm that the overall appearance of the flooring is acceptable.
- ▶ If the room is irregular in shape it may be necessary to square up the tiles off the most important wall or a specific feature.
- ▶ In areas directly adjacent to full height windows, conservatories, orangeries, etc., or areas exposed to direct sunlight for prolonged periods of time or where high temperature fluctuations can occur Polyflor recommend that a suitable high temperature adhesive selected from Polyflor's approved adhesive list should be used to fix tiles/planks in these localised areas only. Contact [Polyflor CTSD](#) on +44 (0) 161 767 1912 for further advice.
- ▶ Prior to laying the first plank, ensure all cuts are of an acceptable length (min. 150mm).
- ▶ As the planks are not required to be laid 'in bond' in the length, it is possible to begin the installation from an end wall.
- ▶ Planks must be staggered to obtain a random finish, however ensure that plank ends are not within 150mm of adjacent planks.

### 6.18.1 Straight Tiling – Setting Out

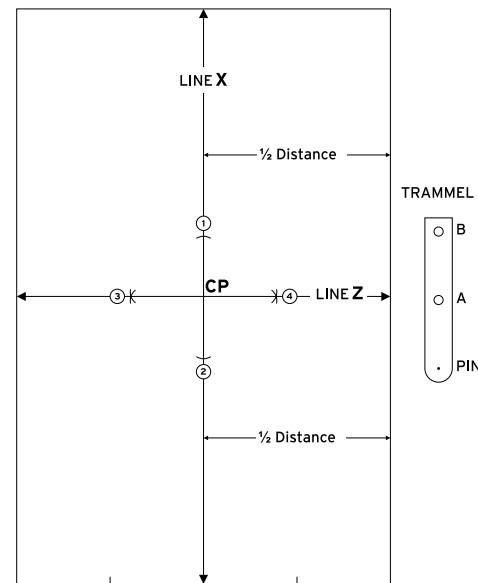

Figure 6.6 Marking out straight tiling

### 6.18.2 Diagonal Tiling – Setting Out

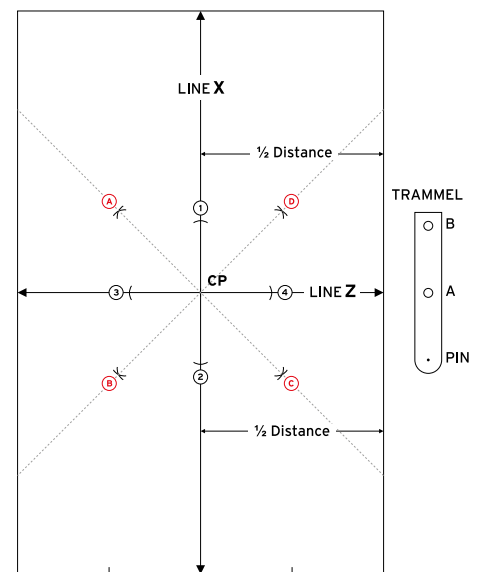

Figure 6.7 Marking out diagonal tiling

- ▶ Measure the room to be laid, in both directions, including any alcoves.
- ▶ Mark a centre line X. Ensure it is central to the room dimensions.
- ▶ Loose lay tiles to ensure there are no small cuts at the perimeter. If small strips are evident, move the centre line across half a tile in either direction to create an acceptable sized cut.
- ▶ Find the centre of line X and mark the Centre Point (CP).
- ▶ Mark arcs 1 & 2 at equal distances from CP on the centre line using point A on your trammel.
- ▶ With points 1 & 2 as centres, use point B on your trammel to draw further arcs intersecting at 3 & 4.
- ▶ Strike a line through point 3 & 4 ensuring it passes through CP.
- ▶ Line Z is now 90° to line X.
- ▶ Double check using the 3,4,5 method.

- ▶ Set out as overleaf for straight tiling. Ensure both lines are at 90° to each other.
- ▶ At CP (Centre Point), use point B on your trammel to mark arcs at 1, 2, 3 and 4.
- ▶ With points 1 & 3 as centres using point B on your trammel draw arcs to intersect each other at A.
- ▶ With points 2 & 4 as centres using point B on your trammel draw arcs to intersect each other at C.
- ▶ Strike a chalk line from wall to wall through points A & C; if no error has been made, this line will pass through CP.
- ▶ With points 1 & 4 as centres using point B on your trammel draw arcs to intersect each other at D.
- ▶ With points 2 & 3 as centres using point B on your trammel draw arcs to intersect each other at B.
- ▶ Strike a chalk line from wall to wall through points B & D; if no error has been made, this line should pass through CP.
- ▶ Double check using the 3,4,5 method.

### 6.19 CUTTING THE PERIMETER TILES

Two techniques are commonly used for cutting perimeter tiles. The choice is mainly dependent upon the run out of the wall.

#### 6.19.1 Overlapping Method

Used when there is little or no run out of the abutting wall.

- ▶ Place the tile to be cut exactly over the last tile laid, ensuring the colour is correct and the decoration runs the correct way.
- ▶ Place another full tile on top of the tile to be cut with its 'top edge' against the wall or set-in coved skirting (Figure 6.8).



Figure 6.8 Measuring using an overlapping tile

- ▶ Scribe a line onto the tile to be cut, using the 'bottom edge' of the top tile as a guide.
- ▶ Cut the tile to the scribed line, loose lay into position and check the fit. Repeat along the whole wall.

#### 6.19.2 Scriber Method

Used when the wall run out is quite severe or when the wall profile cannot be picked up using a straight edge.

##### KEY POINT

Use either Overlapping or Scriber Method to fit around projections such as door frames.

- ▶ Place the tile to be cut exactly over the last tile laid; ensuring the colour is correct and the decoration runs the correct way.
- ▶ Set the bar scriber to the size of the tile being laid.
- ▶ Trace the profile of the wall on to the tile to be cut, ensuring the bar scriber is kept upright and square to the edge of the tile.
- ▶ Cut the tile to the scribed line, loose lay into position and check the fit. Repeat along the whole wall.

Both the Overlapping and Scriber Methods can be used to fit around projections such as door frames. Similarly, a template can be made or a profile gauge containing movable pins can be used for awkward shapes.

### 6.20 INSTALLING TILES IN LARGE AREAS

Maintaining a clearly defined straight line over long distances can be difficult and often leads to inaccuracies. To eliminate this problem, an alternative technique is used when laying tiles in large areas:

- ▶ Establish the central starting point, as described previously, minimising small cuts on perimeter tiles.

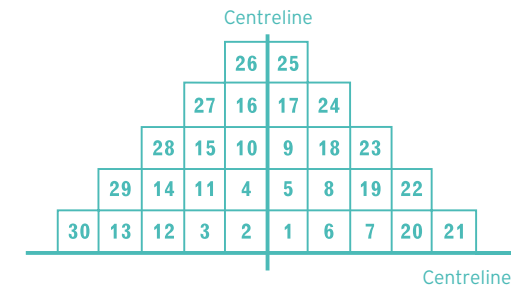

Figure 6.9 Pyramid layout

- ▶ Lay the first pyramid of tiles from the centrelines, using the sequence shown in Figure 6.9. Ensure a close bond is maintained at all times.
- ▶ Repeat this sequence on the opposite side of the centreline. Continue working in larger and larger pyramids, until only the perimeter tiles require fitting.

**NOTE** Construction of a pyramid should always start at the centre of the baseline, working in the same sequence as shown in Figure 6.9.



6.21 INTERLOCKING TILES AND PLANK SYSTEMS

6.22 GENERAL INFORMATION

When installing an interlocking product always follow current local and national standards for the installation of floor coverings. The best current installation practice incorporating the latest technical developments should be employed. The preparation of the subfloor, the installation of the floor covering and the measures taken to safeguard value are key factors in ensuring optimum suitability and performance of resilient floor coverings.

6.23 RECEIPT & STORAGE

On receipt of materials:

- ▶ Check that colours correspond to those ordered and that there is no damage or visual defects in the material.
- ▶ In particular, check that the material is from one batch. Claims for visual defects can only be accepted prior to installation and cutting.
- ▶ The Interlocking plank/tile system must be protected against dirt and moisture during storage.
- ▶ During storage and installation the room temperature should be 20°C (minimum 15°C) and have a relative humidity of 50-60%.
- ▶ Prior to laying the floor, open the boxes and place them in the room in which they are to be installed for a minimum of 48 hours BEFORE the installation commences, so the material can acclimatise itself.
- ▶ Boxes should never be stacked greater than **three** boxes high.

**KEY POINT**

Interlocking tiles & planks should not be stacked more than **THREE** boxes high.

6.24 PREPARATION OF SUBFLOORS

- ▶ The Interlocking plank/tile system can be laid over :
  - Mineral subfloors prepared in accordance with accepted trade standards. It must be clean, durable, permanently dry and flat.
  - Existing floor coverings of ceramic, vinyl and linoleum as long as they are clean, flat and there is no dampness under the floor covering.
  - Wooden floors, floorboards and chipboard floors as long as they are flat, firmly fastened and free of protruding nails etc.
- ▶ Joints in the subfloor must be evened out as a rule the maximum deviation permitted would be 3mm when measured under a 2m straight edge. Higher deviation can cause permanent damage to the locking mechanism.

**KEY POINT**

Carpets and soft floorings are **unsuitable** as a base for the installation of the Interlocking plank/tile system. These will need to be removed.

- ▶ Solid subfloors should demonstrate a maximum damp content of 75% RH before the installation can begin. Residual moisture contents for solid cementitious and screeded subfloors max. 2.0 CM % With underfloor heating 1.8 CM %.
- ▶ Anhydrite floor max. 0.5 CM % (With underfloor heating 0.3 CM %).

**NOTE** Once the subfloor has been prepared the Interlocking plank/tile flooring **must** be laid over the **recommended Polyflor Underlay**.



Figure 6.10 Polyflor Underlay

6.25 PRIOR TO INSTALLATION (UNDERFLOOR HEATING)

Where underfloor heating has been installed within the subfloor:

- ▶ The system should be fully tested and commissioned prior to the flooring installation commencing.
- ▶ Underfloor Heating systems should be switched off and be fully cooled for a minimum of 48 hours prior to the installation commencing. The system should remain off and fully cooled during the time of the entire installation and for a minimum of 48 hours afterwards. Then over several days slowly and incrementally brought back up to the working temperature.
- ▶ A maximum subfloor temperature of 27°C should never be exceeded.

6.26 CONDITIONING

- ▶ The Interlocking plank/tile system must be protected against dirt and moisture both before and during the installation.
- ▶ The climatic conditions acceptable for the installation of interlocking planks/tiles are:
  - Floor temperature > 15°C
  - Room temperature > 18°C
  - Air Relative humidity < 50-60%

## 6.27 INSTALLATION INSTRUCTIONS

During storage and installation the room temperature should be 20°C (minimum 15°C) and have a relative humidity of 50-60%.

In the event of extended deviations from the aforementioned room conditions < 30% or > 80% for relative humidity or temperatures of (< 10°C or > 30°C) a change in the dimensions, gap formation is a typical characteristic for this kind of product; the expansion gap required can therefore increase from those described herein.

In such instances please seek advice from **Polyflor CTSD** by calling +44 (0) 161 767 1912.

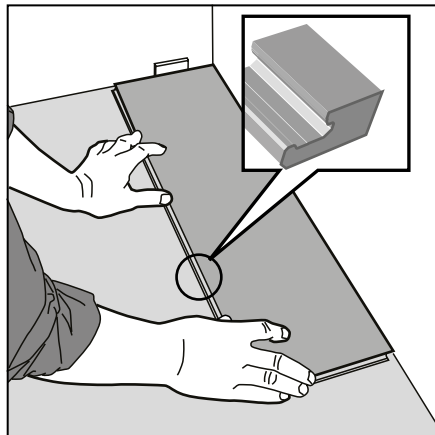

Figure 6.11 First plank, first row

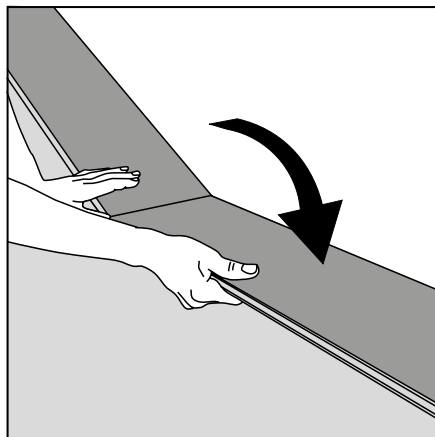

Figure 6.12 Second plank, first row

### 6.27.1 First tile/plank, first row

- ▶ The boards are laid without glue/adhesive. Start to lay the floor in the left-hand corner of the room.
- ▶ A minimum expansion gap of 4mm should be left around the installation perimeter and anything protruding from the subfloor.
- ▶ For larger installations an expansion gap of 1mm per linear metre of room length should be used. e.g. a room 8m x4m would require an expansion gap of 8mm around the entire perimeter of the room and around anything protruding from the floor.

- ▶ Use small offcuts of the tile/plank as spacers between the planks and the walls to help achieve the correct size gap.

### 6.27.2 Second tile/plank, second row

- ▶ Press the short end of the next tile/plank at an angle to the first one, and then lay down. Complete the first row in the same way.

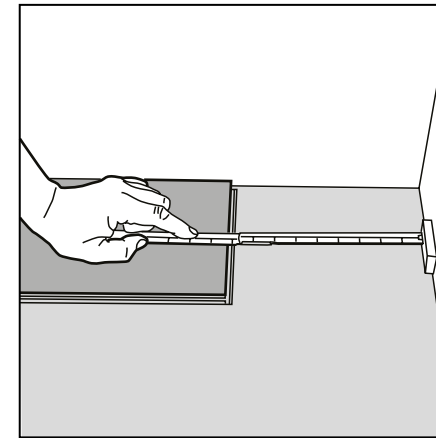

Figure 6.13 Last plank, first row

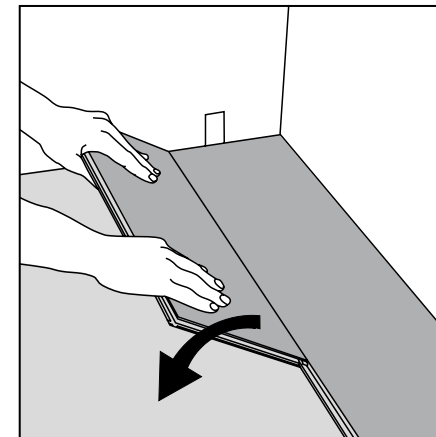

Figure 6.14 First Plank second row

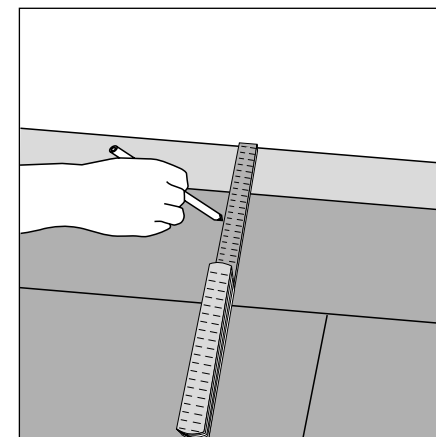

Figure 6.15 Managing uneven walls

### 6.27.3 Last tile/plank, first row

- ▶ Insert correct sized spacer between the end of the first row and the wall to ensure the correct expansion gap is left.
- ▶ Measure the length of the last tile/plank to fit.
- ▶ Cut the last panel to correct length, recommended minimum length is 350mm.

### 6.27.4 First tile/plank second row

- ▶ Insert spacer between the end of the first row and the wall. (Expansion gap).
- ▶ Start the new row with the leftover piece from the last row.
- ▶ Insert the tile/plank at an angle against the plank in the previous row, press forward and fold down at the same time.
- ▶ Always try to stagger the short joints approx. 150mm from a short joint in the previous row.

### 6.27.5 Managing uneven walls

- ▶ If the wall is uneven, the floorboards should be marked or scribed to its contours.
- ▶ Mark the floorboards with the contour of the wall. Don't forget to include the required expansion gap to the wall.
- ▶ To cut the planks to fit the last row, position them one at a time directly over the previous row in the direction you'll be laying them.
- ▶ Hold them firmly in place. Then line up a third board on top.
- ▶ Use the edge of this board to mark the cutting line with a pencil on the board beneath. Remember to allow for the expansion gap (Figure 6.15).

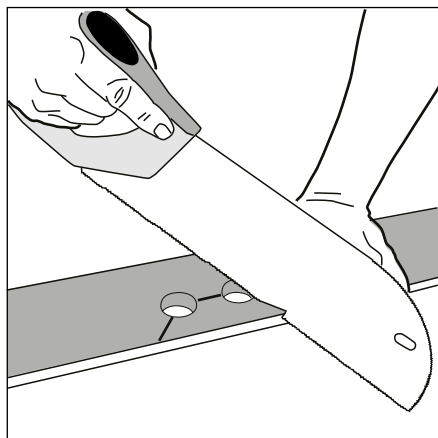

Figure 6.16 Radiator pipes

### 6.27.6 Radiator Pipes (Figure 6.16 & 6.17)

- ▶ Principle cut out – mark the centre of the holes on both the long and short sides using a carpenter's square and a pencil.
- ▶ Where the marks cross drill a pilot hole using a thin #6 or #8 drill bit. Further drill the hole with a spade bit wide enough to accommodate both the diameter of the pipe and the required expansion gap.
- ▶ Cut around as shown with a saw or with a sharp utility knife. Install the floor plank.
- ▶ If necessary, put a bead of contact glue on the cut piece and replace. Insert a spacer directly behind the inserted piece to wedge it in place ensuring that the correct sized expansion gap has been left. Leave this in place until the glue has hardened.

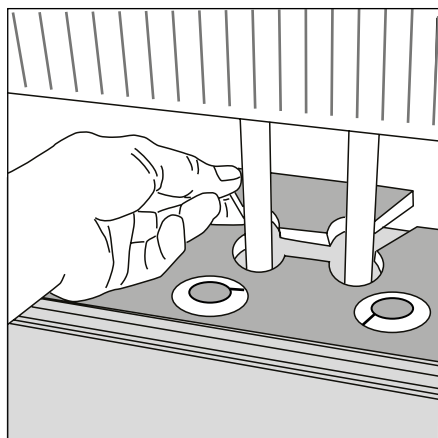

Figure 6.17 Radiator pipes

### 6.27.7 Door Frames (Figure 6.18)

- ▶ When installing Interlocking plank/tile around a door frame, cut into the door frame with a handsaw, using an off cut plank/tile and some underlay as a guide for the height and the amount to trim off the door frame.
- ▶ Slide the cut piece under the door frame.

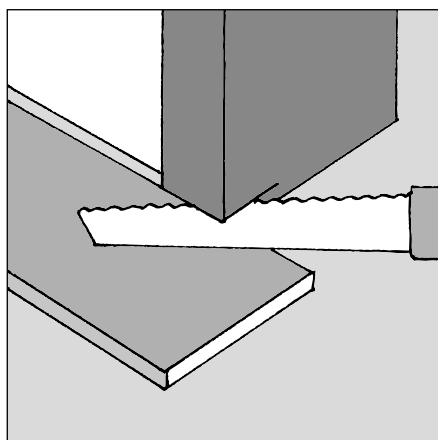

Figure 6.18 Door frames

### 6.27.8 Adjoining other floor coverings

- ▶ When adjoining other floor coverings, finish the Interlocking plank/tile in the doorway.
- ▶ An appropriate expansion gap should be left between the Interlocking plank/tile and the adjoining floor covering.
- ▶ This can be covered using a suitable threshold or diminishing strip later.

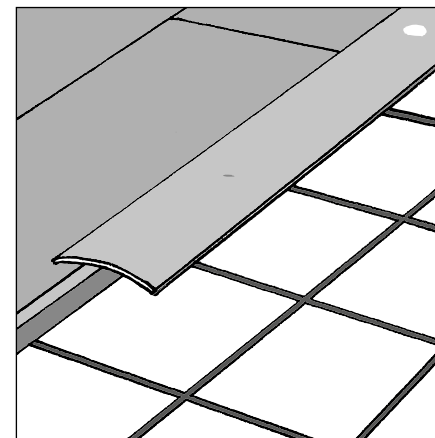

Figure 6.19 Threshold strip

### 6.27.9 Installing across multiple rooms (Figure 6.19)

- ▶ Finish the Interlocking plank/tile in the doorway on either side and allow a break between the two floors of double that left around the perimeter.
- ▶ A suitable threshold strip can then be installed to cover the resultant gap. Place two small off cut pieces of Interlocking plank/tile back to back to gauge the correct gap size.
- ▶ When installing a threshold never mechanically fix direct to the Interlocking plank/tile; instead affix to the subfloor and allow sufficient space between the top edge of the threshold and the surface of the Interlocking plank/tile so as to allow movement into the expansion gap.

## 6.28 COMPLETION WORK

Interlocking plank/tile are designed as floating floors hence the floor covering can be walked on directly after it is installed.

- ▶ Remove all the spacers and wedges from the edge expansion gaps.
- ▶ Skirting boards, base boards, quadrants or scotia can be used to conceal the expansion gap, however they should never be fitted directly onto the surface of the interlocking plank/tile.
- ▶ Leave a small gap between the two, allowing for the natural movement of the plank underneath the skirting or scotia.

**NOTE** Shades that illustrate heavily embossed surfaces will require a slightly larger gap between the surface of the plank/tile and the underside of the skirting/scotia etc. to accommodate free movement into the expansion gap.





- CONTENTS
- INTRODUCTION
- SUBFLOORS
- SHEET
- TILES
- LVT
- LOOSE LAY
- ESD
- POLYGLAD
- WELDING
- BORDERS
- FINISHES
- CHEMICALS
- TEMPERATURES
- MAINTENANCE



# INSTALLATION OF ESD

The installation of Electro Static Dissipative (ESD) vinyl floor covering.

## 7.1 OVERVIEW

The Polyflor ESD family of vinyl floor coverings consists of products which are designed to meet specific resistance requirements. The terminology used to describe the various categories was changed in 1999, as the IEC (International Electrotechnical Commission) brought together the various electronics industries to ensure that the same terminology is used by all parties.

### ▶ Antistatic

These products do not accumulate static charges above 2.0 KV and are classified as 'Antistatic' when tested to EN1815. For specialist application where there is a requirement to dissipate the charge, see Polyflor ESD product ranges.

### ▶ Static Dissipative (SD)

These products when tested to the test methods identified in our literature have a resistance to earth between  $1 \times 10^6$  and  $1 \times 10^9$  ohms.

### ▶ Electrostatic Conductive (EC)

These products when tested to the test methods identified in our literature have a resistance to earth between  $10^4$  and  $\leq 10^6$  ohms.

### ▶ Polyflor Royal Ordnance Factory (ROF)

These products when tested to the test methods identified in our literature have a resistance to earth between zero and  $5 \times 10^4$  ohms.

## 7.2 SPECIFYING THE CORRECT PRODUCT

The Polyflor ESD family of products is designed to minimise or eliminate the risk of Electro Static Discharge (ESD) and it is essential that the correct product be selected for the intended application.

An electrical performance specification must be identified at the outset. This will not only stipulate the maximum and minimum electrical resistance requirements of the installed floor, but will also identify the method of test, the electrodes to be used, the method of measurement and the testing environment.

From this information, the correct Polyflor ESD product can be identified, taking into account both the electrical performance and the method of installation. Whenever specifying a Polyflor ESD vinyl floor covering, Polyflor strongly recommends that you discuss your requirements with our [Customer Technical Services Department \(CTSD\)](#). They will advise on which products are best suited for the particular application, and where no specification has been identified, will advise on the specifications used in similar installations and industries.

### 7.3 ISOLATION OF SUBFLOOR

**KEY POINT**

Suspended timber subfloors are not conductive and do not require an isolating barrier.

The electrical conductivity of a solid subfloor can vary greatly, and as a result the installed floor may have resistances lower than the minimum stated in the specification. Cementitious underlayments provide an isolating barrier of known resistance beneath the vinyl floor covering.

- ▶ Polyflor recommends that all solid subfloors should be covered with a cementitious underlayment which must be at least 3mm thick.
- ▶ The choice of underlayment is dependent upon the end use location, and consideration should be given to such properties as point load resistance and protein content.
- ▶ The underlayment should be allowed to dry prior to the application of the floor covering.

**NOTE** Polyflor accepts no responsibility for non-conformance due to the resistance of the installed floor being below the minimum specified, if an isolating barrier has not been used.

### 7.4 CONDUCTIVE ADHESIVES

Polyflor recommends the use of Polyflor conductive adhesive for all Static Control floor coverings and Polyflor contact adhesive for earthing strips. If alternative adhesives are used, they must be recommended by the adhesive manufacturer and approved by Polyflor.

**NOTE** Access panels vary from manufacturer to manufacturer, both in design, materials used and electrical performance specification. We recommend discussing your individual requirements with your panel supplier or alternatively with Polyflor CTSD.

### 7.5 CONDUCTANCE TO EARTH

- ▶ Installing an earth system is a prerequisite for all ESD floors. This gives the end user the ability to test to earth. It ensures the conductance of the installed floor is to a known earth via a predetermined and controlled path.
- ▶ The choice of material used for the earth system can be brass, copper or stainless steel and should be nominally 50mm wide and 0.1mm thick. The width and gauge are governed by the performance standard for products such as Polyflor ROF.
- ▶ The use of at least two connections to earth is recommended; if the first is disconnected or damaged, the second is a security back-up.
- ▶ Connection of the earth system to the building earth is normally carried out by a qualified electrician and not the flooring contractor.

### 7.5.1 Polyflor Static Dissipative (SD) range, OHmega EC and Polyflor EC

- ▶ The earth strip is laid 150mm from one side of the room, in the same direction as the vinyl sheets are to be laid. This strip is connected to a known earth (Figure 7.1).

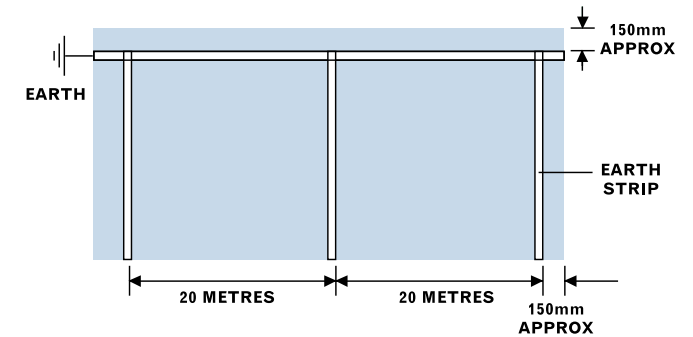

Figure 7.1 Earthing strip layout

- ▶ A second strip is laid at 90° to the first, 150mm from the edge and running full width across the room.
- ▶ Further strips are laid at 20 meter intervals as determined by the size of the room.

### 7.5.2 Conductive ROF and Polyflor EC to JSP 482 Standard

- ▶ With this type of flooring, a Stainless Steel earth grid using the correct size strip (50mm wide, 0.2mm thick) is preferred.
- ▶ The strips should be laid to form 600mm square grid across the floor, the perimeter strips being 150mm from the wall (Figure 7.2).
- ▶ At least 2 Earth points should be connected at suitable locations.
- ▶ Confirmation of the layout of the grid with the end user is important as there are variations in the requirements for some military specifications.

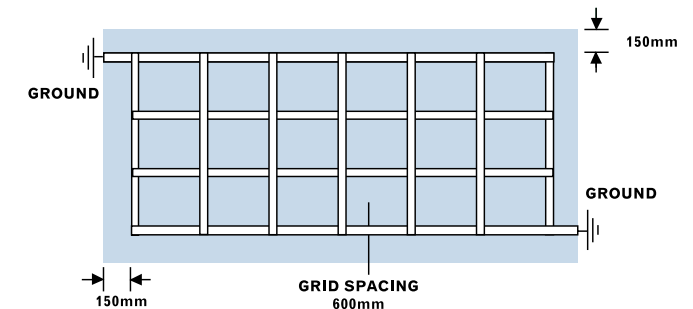

Figure 7.2 Earth strip layout

## 7.6 INSTALLATION METHODS

The basic techniques for installation of Polyflor ESD floor coverings are the same as described for standard vinyl sheet and tile in Sections three and four respectively; however there are a number of important differences:

### 7.6.1 ESD Vinyl Sheet

Polyflor ESD vinyl sheet should be installed by the double drop method. This is because the conductive adhesive contains carbon, which results in low tack.

- ▶ Once the adhesive has been spread, the vinyl sheet is laid into it and pressed all over to ensure an even transfer of adhesive.
- ▶ The vinyl sheet is then folded back and left until the adhesive becomes tacky.
- ▶ When the adhesive is tacky, the vinyl sheet should be accurately re-laid, ensuring it does not twist or trap air bubbles.
- ▶ Seams must be without gaps and any excess adhesive should be removed as work proceeds.
- ▶ The vinyl sheet is then rolled with a 68kg articulated floor roller in the short direction first, then the long, and the rolling repeated between one and four hours later.

### 7.6.2 ESD Vinyl Tiles

Polyflor ESD vinyl tiles are installed by the same method as standard vinyl tiles - the single stick method. The grid layout for static control tiles is the same as for sheet vinyl, as described previously.



ESD vinyl tiles must always be heat welded. For further information on heat welding can be found in Section nine.

## 7.7 SPECIAL PRECAUTIONS

Special precautions must be taken with the following products:

### 7.7.1 Electrostatic Conductive (EC) Floor coverings

#### POLYFLOR ESD

Conductive welding rod is **not** a requirement with ESD floor coverings.

Pipes or metal projections such as metal gullies, door spring plates etc. must be insulated from the EC floor covering and free from conductive adhesive. The following method of installation is recommended:

- ▶ Cut the EC floor covering 50mm short of any pipe or metal fixture.
- ▶ This infill area should be laid with a suitably coloured standard Polyflor sheet vinyl, adhered with a non-conductive adhesive.
- ▶ This infill piece should then be welded to the ESD floor covering with a standard weld rod.

### 7.7.2 Conductive Floor covering

Polyflor Conductive does not provide protection from a short circuit on a 240/250 volt mains. Where this material is installed, all electrical equipment and switches must be located outside the building. No portable electrical tools should be used inside, unless earth leakage circuit breakers are fitted to the switchgear.

## 7.8 HEAT WELDING

All Polyflor ESD floor covering installations (excluding access panels) must be heat welded. Ideally, the floor should be left for a minimum of 24 hours before welding the joints. This will prevent adhesive bubbling up into the seams when heat is applied.

**NOTE** The relative humidity and temperature are only critical for Polyflor Static Dissipative floor coverings.



Further information on heat welding can be found in Section nine

## 7.9 TEST METHODS

Worldwide, there are a great many test methods for electrical grade floor coverings and, with rapid developments in the electrical and electronic industries, standards are constantly being reviewed.

To ensure that the floor is tested to the latest specification, it is suggested that the architect or specifier obtain a copy of the test method and requirements from the local office of the National Standards Authority. This should then be attached to the specification prior to the ordering of materials and installation of the floor.

The following procedure is recommended and approved by Polyflor if a test method is not specified:

### 7.9.1 Test Conditioning

It is essential to condition the floor prior to testing. The floor should be cleaned at least 24 hours before testing, and then conditioned for 24 hours at 40-60% RH and 20-25°C.



Further information on cleaning can be found in Section fourteen

### 7.9.2 Test Procedure (BS 61340-4-1)

The electrical testing of the floor must be carried out with an insulation tester, operating at 10 volts D.C. / 100 volts D.C.

### 7.9.3 Test Electrodes (BS 61340-4-1)

A compliant electrode consists of a brass cylinder 63.5mm (2.5 inches) in diameter, weighing 2.27kg. (5lbs). On the underside is attached a round conductive rubber pad - of 5mm thickness and 65mm in diameter.

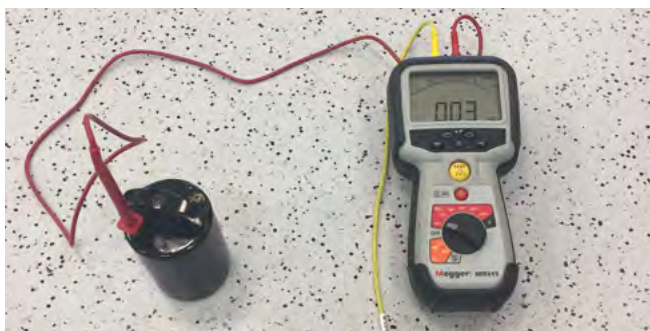

Figure 7.3 Test electrode

**NOTE** The test may not be reliable if made within 24 hours of the flooring being laid or cleaned.

### 7.9.4 Test Method (BS 61340-4-1)

One electrode should be placed on the floor. The second connection should be made to the earth point, the resistance being measured between the electrode and a known earth. One test should be made for every 2 square metres of flooring.

### 7.9.5 Testing to a Grid

The procedure of always testing the same points 'on a grid' is not recommended. The whole floor should meet the specification, not just selected points. To ensure continual performance of the whole floor, it should be periodically tested at random points.

### 7.9.6 Test Results

Polyflor ESD floor coverings are manufactured to specific levels of conductance and are tested, prior to despatch, in laboratory conditions. On-site testing not only takes into account the floor covering, but also the adhesive, the subfloor and the environment.

To ensure the whole installation meets the specification requirements **Polyflor CTSD** offers a fee based, finished installation testing service. Find out more by calling +44 (0) 161 767 1912.

When installed and tested in accordance with the instructions laid down by Polyflor and detailed in this manual, the electrical resistance should be as follows:

EARTH TEST RESULTS		
	MINIMUM	MAXIMUM
Static Dissipative	1 x 10 <sup>6</sup> ohms	1 x 10 <sup>9</sup> ohms
OHmega EC	10 <sup>4</sup> ohms	1 x 10 <sup>6</sup> ohms
Polyflor EC	5 x 10 <sup>4</sup> ohms	1 x 10 <sup>6</sup> ohms
Conductive ROF	Zero ohms	5 x 10 <sup>4</sup> ohms

### 7.10 STATIC CONTROL SYSTEMS

In many instances, a Polyflor ESD floor covering is sufficient to give the necessary control, but in highly static-sensitive areas, additional precautions may be necessary.

These include:

- ▶ Dissipative clothing and footwear
- ▶ Wrist and heel straps
- ▶ Special work stations
- ▶ Dissipative packaging and sealing
- ▶ Ionisers and humidity controllers



# INSTALLATION OF FLEXIBLE WALL COVERING

The installation of vinyl wall coverings.

## 8.1 RECEIPT & STORAGE

On receipt of rolls

- ▶ Check that colours correspond to those ordered, that quantities are correct and that there is no damage.
- ▶ In particular, check that rolls are from one batch, if that was requested on the order.

**NOTE** The wall covering features a subtle marbelised decoration.

- ▶ On arrival at site, the rolls should be safely secured in an upright position and stored, together with the adhesive, at a minimum temperature of 18°C for at least 24 hours before laying.
- ▶ Inflammable adhesives require special storage conditions. Contact the adhesive manufacturer or see current literature for details.
- ▶ To achieve best results, site conditions should be as described in BS 8203. A working temperature of between 18°C and 27°C is required for at least 24 hours prior to, and during, the laying period and for 24 hours afterwards. Conditioning areas and laying areas should be of similar temperature, to prevent thermally induced dimensional changes.

## 8.2 PREPARATION OF WORK AREA

### FIRE RATING

The substrate should be either bare plaster or plasterboard composition in order to achieve a Class 'O' fire rating\*.

- ▶ The wall surface must be smooth, sound, clean and dry.
- ▶ All paint, oil, grease, dust and any other contaminants liable to impair adhesion must be removed, prior to application of the wall-cladding.
- ▶ Plaster and plasterboard are ideal substrates.

\* The Class 'O' fire rating as defined in the UK Building Regulations for vinyl to walls and ceilings.

## 8.3 INSTALLATION

- ▶ Prime the areas of plastered wall with a primer, as recommended by the adhesive manufacturer, and allow to dry completely.
- ▶ Mark the first vertical line on the wall using a plumb line. Use only pencil for marking the wall and vinyl.
- ▶ Cut the vinyl sheet to size, allowing a small amount for cutting in.
- ▶ Apply a recommended contact adhesive 150mm wide at the top edge of the wall, adjacent to the ceiling and corresponding to all pressure points, such as external and internal angles and coved radius.
- ▶ Prior to placing the vinyl into position, and to give extra support, it will be necessary to apply a recommended contact adhesive to the back of the vinyl, approximately 150mm deep at the top edge, and corresponding to the pressure points, such as external and internal angles and coved radius. Allow to become touch dry before applying the vinyl.
- ▶ Roll up the vinyl with the face innermost, and with the decoration running either vertically or horizontally, dependent on the size of roll, wall and application preference.
- ▶ Spread a further coat of recommended adhesive as directed by the adhesive manufacturer, to the prepared wall surface.
- ▶ When ready, and working to the vertical line on the wall, apply the vinyl to the line, ensuring there are no ripples or run-outs.
- ▶ Roll the entire area using a flooring grade hand roller, from the centre outwards, to exclude air. A second rolling will be necessary.

## 8.4 SUGGESTED INSTALLATION METHOD

### 8.4.1 External angles

To enable the wall covering to be formed around external corners, it will be necessary to fit and adhere 'Polyflor Ejecta EFA75' corner cap profile to all external corners.

- ▶ Fit and adhere the EFA75 corner cap profile to all external corners. Use a recommended contact adhesive to secure the EFA75, and press firmly.
- ▶ When all the corner cap profile is fixed, apply contact adhesive to the surface and to 150mm either side of the corner edge. Allow to become touch dry before applying the vinyl sheet.
- ▶ Apply contact adhesive to the corresponding area on the back of the vinyl and allow to go touch dry before installing.

### 8.4.2 Internal angles

To enable the wall covering to be formed around internal corners, it will be necessary to fit and adhere 'Polyflor Ejecta' cove former to all internal corners.

- ▶ Fit and adhere the cove former to internal corners and at the junction of the ceiling and top of the wall. Use a recommended contact adhesive, and press firmly. First, fit the mitres in the corners, and at the junction of the ceiling and top of the wall. For ease of use, short lengths of approximately 300mm are recommended.
- ▶ When all corners are completed, fit and adhere the longer straight lengths, using the same method. When all the cove former is fixed, apply contact adhesive to the face of the cove former and 150mm either side of the corner edge. Allow to become touch dry before applying the wall covering.
- ▶ Apply contact adhesive to the corresponding area on the back of the sheet and allow to go touch dry before installing.
- ▶ All joints should be heat welded on completion, allowing at least 24 hours after fitting for sufficient moisture to dry out of the adhesive. Finally, trim welds when cold to prevent sunken welds.

**KEY POINT**  
Do not attempt to take large pieces of wall covering around corners. The walls may not be vertical or square, and can cause a runoff or possible rucking of the vinyl at the next seam. In these instances, work to 150mm around the corner.

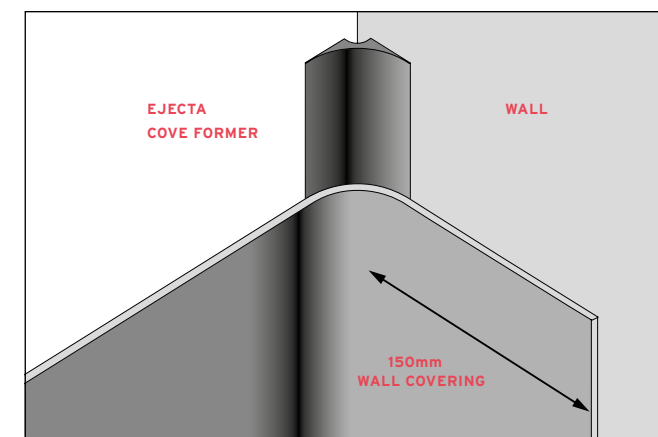

Figure 8.1 Ejecta cover former

### 8.4.3 Overlap method

In addition to the traditional method of abutting the wall covering to vinyl flooring we are now able to recommend the overlap method of installation for Polyflor wall cladding in conjunction with 2mm barefoot and shod Polysafe floor coverings. This method of installation ensures a watertight finish from floor to ceiling in areas where levels of hygiene may be critical.

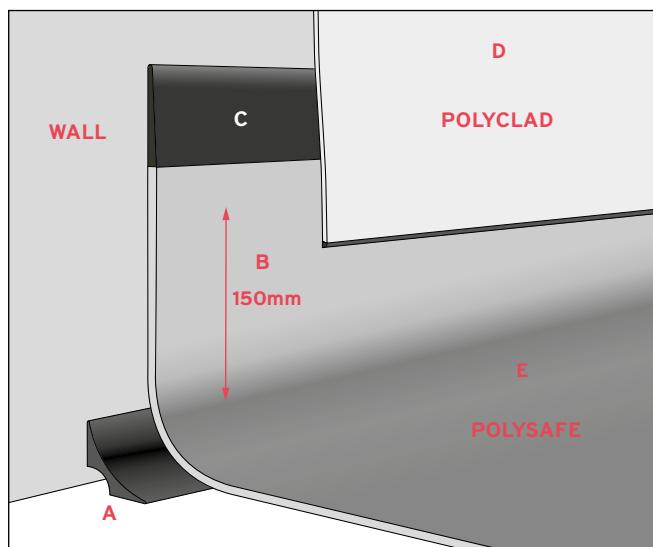

Figure 8.2 Overlap installation method

- ▶ Using a Cove Former (A), cove the Polysafe flooring (B) 150mm up the wall.
- ▶ Using a Diminishing Strip (C), abut the top of the floor covering.
- ▶ Stick the diminishing strip to the wall with a contact adhesive.
- ▶ The wall covering is adhered to the diminishing strip with a contact adhesive and over the floor covering to the required height.
- ▶ A minimum overlap of 50mm is recommended.
- ▶ Double sticking the product ensures a strong bond. The bottom edge is sealed with a heavy duty silicone sealant (E).

If further information is required, please contact the **Polyflor Customer Technical Services Department (CTSD)** on +44 (0) 161 767 1912.



# WELDING

Polyflor strongly recommends vinyl sheet and 608mm vinyl tile floorings are welded, this includes the internal and external joints when the vinyl sheet is site cove formed.

## 9.1 CORRECT TOOLS

Having the correct tools in good condition is a prerequisite of good heat welding. The tools required are dependent upon preferred methods but Polyflor recommend the following:

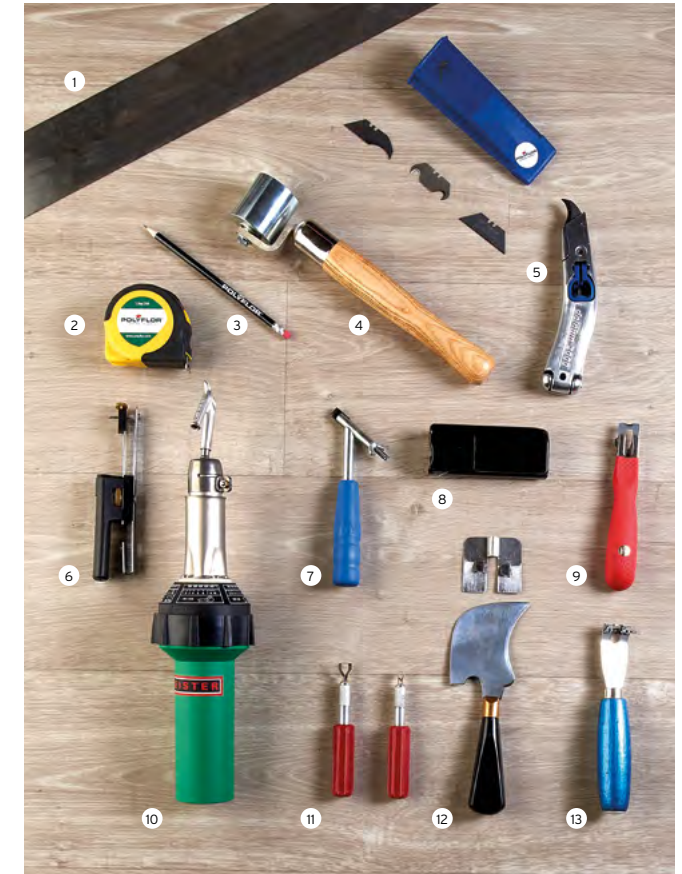

- |   |  |
|---|--|
| 1. 2 metre straight edge                    | 8. Seam cutter                                 |
| 2. Tape measure                             | 9. Mozart trimming tool                        |
| 3. <b>Sharp</b> pencil                      | 10. Welding equipment<br>(manual or automatic) |
| 4. Hand roller                              | 11. Exacto trimming tools                      |
| 5. Suitable bladed knives                   | 12. Spatula trimming knife                     |
| 6. Recess scribe                            | 13. Hand grooving tool                         |
| 7. Grooving tools<br>(manual or mechanical) |  |



## 9.2 WELDING IS MANDATORY ON MOST SPECIFICATIONS

Most specifications make welding mandatory, since it prevents ingress of dirt and bacteria into seams and provides a floor surface which is impermeable to water. Although seam welding is a recognised installation technique - instructions can vary by manufacturer. When installing Polyflor sheet products only Polyflor seam welding instructions should be followed.

Welding will aid maintenance of high standards of hygiene. By carefully following these guidelines; and executing correctly welding will eliminate seam failures. In Healthcare establishments especially this is a prerequisite and high standards of heat welding are demanded under the guidance from NHS Infection Control Teams (NHS Health Building Note 00-10 Part A Flooring March 2013).

## 9.3 HEAT WELDING

Heat welding of vinyl floor coverings has been used successfully for many years and employs the technique of heating both the vinyl flooring and the vinyl welding rod to a sufficient temperature to melt and fuse them together. The procedure is the same for both sheet and tile installation with the exception that the edge of the tiles do not require cutting in prior to grooving.

## 9.4 CUTTING IN THE SEAMS

**Factory edges should never be butted together** but should be overlapped and cut by one of the following methods:

### 9.4.1 Using Seam Cutters

#### PLEASE NOTE

Complaints arising from the failure of welds due to not trimming off factory edges will not be accepted by Polyflor Ltd.

- ▶ Polyflor recommends that the sheet is overlapped at the seams by a minimum of 10mm.
- ▶ Set the first cutter to the thickness of vinyl sheet. Using the factory edge as a guide, trim off 6mm along the length. Where it is not possible to use the seam cutter against the wall, or in other areas of restricted access, use a straight edge and straight bladed knife held squarely to the floor.
- ▶ Set the second cutter to the thickness of vinyl sheet. Using the edge previously cut on the top sheet as a guide, cut through the bottom sheet. Remove the scrap piece of material.

### 9.4.2 Using a Recess Scriber

- ▶ Prior to overlapping the vinyl sheet, trim off the factory edge on the bottom sheet. This is best done by striking a chalk line, then - using a utility knife and straight edge - cut through to remove the scrap piece.
- ▶ Overlap the top sheet and then trace the bottom edge onto the top sheet with a correctly set recess scriber.
- ▶ To highlight the scribed line, rub some chalk dust into the surface. Trim the top sheet to the scribed line.

### 9.4.3 Double Cut

- ▶ Using a straight edge and keeping the utility knife upright, cut through both layers to ensure there is a tight seam.
- ▶ Once the seam is cut, discard the waste material and check the final appearance.

## 9.5 GROOVING THE SEAMS

Prior to welding, some of the material must be removed from the seam, creating a groove profile that will accept the vinyl welding rod.

Two shapes of groove profiles can be cut:

### 9.5.1. A 'U' shape profile

This leaves a semi-circular groove in the vinyl and should extend into the vinyl for  $\frac{2}{3}$  of its thickness, up to a maximum of 2mm.

### 9.5.2. A 'V' shape profile

This leaves a 60° triangular groove in the vinyl and should extend into the vinyl for  $\frac{7}{8}$  of its thickness.

**NOTE** The 'V' shaped groove profile has proven particularly suitable for embossed versions of Polysafe vinyl sheet floor covering.

## 9.6 MANUAL GROOVING

- ▶ Place the centre of the grooving tool over the centre of the seam.
- ▶ Bring up the straight edge to touch the side of the grooving blade and align the straight edge, maintaining an even distance from the seam.

#### FOAM BACKED

The groove on foam backed ranges such as Acoustic and Sports flooring should only be cut in the vinyl wear layer; **NOT** cut through to the PVC foam backing.



Figure 9.1 Grooving the seam

- ▶ Pulling the tool towards you, groove to the required depth. Move the straight edge as required and repeat until the whole seam is grooved.
- ▶ Sweep well to remove any dust and trimmings from the groove.

## 9.7 POWERED GROOVING

- ▶ Set the blade to the correct depth of cut.
- ▶ Align the guides with the cut seam. Press the cutter in to the full depth of cut and then move forward following the cut seam.

- ▶ Use hand tools to complete grooves next to walls, skirtings etc.
- ▶ Sweep well to remove any dust and trimmings from the groove.
- ▶ Never use a powered grooving machine with a standard blade on Polysafe safety vinyl sheet ranges. The silicon carbide and aluminium oxide particles will destroy the blade. A diamond blade is commonly used on Polysafe floor coverings.

### 9.8 PRIOR TO WELDING THE SEAMS

Before commencing heat welding Polyflor recommends leaving the adhesive to set for a minimum of 24 hours. This should ensure the adhesive does not bubble up when heat is applied; bubbling will adversely affect seam strength.

If in any doubt contact [Polyflor Customer Technical Services Department \(CTSD\)](#) on +44 (0) 161 767 1912.

### 9.9 WELDING THE SEAMS

- ▶ Ensure nozzle attachment is free of debris – clean with a wire brush.
- ▶ Pre-heat the welding gun to a setting appropriate to both the material and the site conditions ensuring that the nozzle is pointing upwards during this pre-heat period.
- ▶ Try out the welding rod on a scrap of material to ensure the temperature is correct and that fusion is taking place. Adjust accordingly. When you are satisfied that the temperature is correct, you can proceed to weld the joint.
- ▶ Place the welding rod into the nozzle aperture. Starting as close as possible to the end of the room, press the welding rod down into the groove with the nozzle attachment, the toe of which should be parallel to the vinyl surface. Pull the gun towards you whilst maintaining the downward pressure (Figure 9.2). Ensure the gun is kept square to the floor. With your spare hand, alternately check the weld security and that the welding rod is feeding freely.
- ▶ Typically, you would start welding from the edge of the room towards



Figure 9.2 Applying the weld

#### KEY POINT

Ensure a constant rate of welding. Moving slowly will 'burn' the vinyl and moving quickly will not fuse the welding rod. The finished width of the weld may also vary and detract from the appearance.

the centre. At this stage, pull the gun away from the groove and cut off the welding rod. Using a trimming tool and guide trim off the excess welding rod. Commence welding as before, from the opposite end of the room. Run out the weld into the pre-cut 'V' (Figure 9.3) and cut off the excess welding rod.



Figure 9.3 Weld joins

- ▶ Where Ejecta set-in skirtings are used, the horizontal seam between the skirting and the Polyflor sheet should be hot welded as described previously however the vertical joints and mitres should not be hot welded; simply neatly abutted/scribed.

### 9.10 TRIMMING THE WELD - Spatula or Mozart Tool

Prior to commencing, it is advisable to ensure that your preferred trimming tool has a sufficiently sharp and properly defined blade profile. This keen edge will make trimming easier and minimise the risk of damaging the product. Trimming of the weld must be carried out in two stages. Failure to follow this procedure will result in welds which are prone to dirt pickup.

- ▶ Place the trimming guide and blade over the welding rod and push the knife forward and trim off the top layer of welding rod (Figure 9.4a or 9.4b). This can be done whilst the weld is still warm. Trimming the weld speeds up the cooling time.



Figure 9.4a Trimming off the weld top layer (Spatula Trimming Knife)

Welding Techniques are covered on the 3 & 4 day Polyflor Floor Laying Courses



**KEY POINT**

Polyflor foam backed vinyl sheet flooring is liable to compression and sometimes, even after the final trim, the weld is proud of the floor. In this case using a Mozart trimming tool in preference to a traditional spatula is advisable.



Figure 9.4b Trimming off the weld top layer (Mozart Trimming Tool)

- ▶ When the remaining weld has cooled to room temperature, the excess weld should be trimmed using the trimming blade with the guide removed. Keep as shallow an angle as possible between blade and floor to avoid the risk of damaging the product (Figure 9.5a or 9.5b).



Figure 9.5a Final trim after the weld has cooled (Spatula Trimming Knife)



Figure 9.5b Final trim after the weld has cooled (Mozart Trimming Tool)

**9.11 GLAZING THE WELD**

Should a glazed finish be required this can be achieved with the nozzle attachment removed but still on the same heat setting; play the standard gun nozzle over the trimmed weld. Repeat over the whole length of the weld, keeping the gun moving constantly to prevent burning.



Figure 9.6 Final weld

**9.12 COLD/CHEMICAL WELDING**

- ▶ Once the seam has been accurately cut as described previously in 9.4 and remembering that this type of welding should not be considered as gap filling, the seam can be welded.
- ▶ Cover the seam with the correct grade and width of masking tape; (min. 25mm wide) to prevent any excess welding liquid coming into contact with the vinyl surface.
- ▶ Cut through the tape at the seam, using a trapezoid or rolling knife with a sharp blade. Apply the welding liquid (Figure 9.8), as per the Werner Muller instructions, ensuring both hands are controlling the tube.

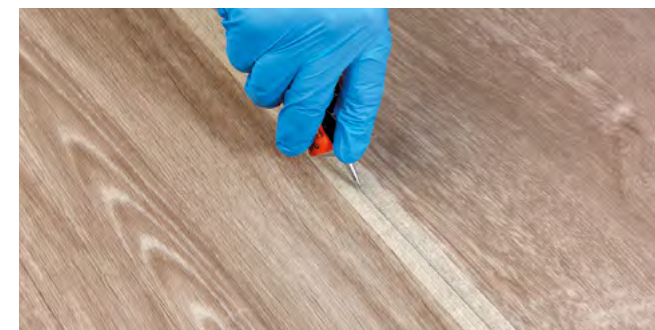

Figure 9.8 Cold welding

- ▶ Keep fingers away from the needle applicator.
- ▶ After approximately 10 minutes and once the welding liquid has cured, the masking tape should be carefully removed.

**9.13 WELDING OF RUBBER SHEET**

Welding of rubber sheet is not a prerequisite in most installations. However, where there is heavy wet cleaning or where due to hygiene requirements a continuous smooth surface is demanded, the joints should be heat welded using the recommended weld rod.

# INLAID DESIGNS & BORDERS

Conditioning & installation instructions of inlaid designs and borders.

## 10.1 INTRODUCTION

The Polyflor Design Service inlaid motifs and border designs are manufactured under strictly controlled conditions to produce the close-fitting pieces which make up the design. To duplicate the close-fitting on site, it is important to ensure the design is correctly conditioned prior to laying.

## 10.2 CONDITIONING

The Polyflor Design Service waterjet design should be removed from the packaging and laid on a flat surface and conditioned, together with the rolls of vinyl or vinyl tiles and water-based adhesive, at a temperature of at least 18°C (64°F) for a **minimum of 24 hours** prior to and during installation, and at least 24 hours afterwards.

## 10.3 WELDING - DRY AREAS

Welding is not a standard requirement of the Polyflor Design Service waterjet designs and should only be carried out on the most simple of designs such as squares, circles etc.

Where border designs are to be incorporated into the floor, consideration as to whether welding would affect the definition of the border lines, thus affecting the finished appearance, should be given.

## 10.4 WELDING - WET AREAS

Where motifs or designs are to be laid into wet areas, either an approved epoxy resin or polyurethane adhesive should be used. Alternatively the motifs or designs could be welded after consideration of the effect on the finished appearance.

## 10.5 INSTALLATION INSTRUCTIONS FOR MOTIFS (with a rectangular outer frame)

As normal practice, slab the lengths and fit and loose lay the main area.

- ▶ Place the Polyflor Design Service motif into position on top of the loose laid material and secure with masking tape to prevent movement.
- ▶ Trace the top and right hand side of the rectangular edge frame with a knife and remove the motif. Also trace a diagonal line from the start point to the finish point, forming a triangle. Cut through and remove triangle waste.
- ▶ Reposition the motif so that it butts up tightly to the two newly cut edges. The two remaining sides can now be traced and cut through.

1. By cutting in the rectangle in two stages, a tighter joint will result.
2. Always trace and cut through in one direction for best results.



- ▶ Adhere the motif using a correctly notched trowel and approved adhesive, and roll with a 68kg roller.
- ▶ Remove clear film from the face of the motif and remove any adhesive traces. Any minor adjustments to the motif should be made whilst the adhesive is wet.
- ▶ Fold back the main length(s) away from the motif, and adhere as above. Ensure when placing the material into the adhesive that the joint(s) abutting the motif are tight, and roll with a 68kg roller.
- ▶ Turn back the other half of the length and adhere and roll as before.



### 10.6 INSTALLATION INSTRUCTIONS FOR ALL MOTIFS/DESIGNS

For best results the following method should be followed, this will minimise the risk of cutting into the design.

- ▶ Place the Polyflor Design Service motif into position and mark around with a pencil – this will act as a glue line.
- ▶ Adhere the motif using a correctly notched trowel and approved adhesive and roll with a 68kg roller.
- ▶ Remove clear film from the face of the motif and remove any adhesive traces. Any minor adjustments to the motif should be made whilst the adhesive is wet.
- ▶ As normal practice, slab the lengths, fit and loose lay the sheet material into the area. Trim the excess back which is overlapping the motif to within a 25mm overlap.
- ▶ Fold back the main length(s) away from the motif, and adhere as above. Ensure when placing the material into the adhesive that the seams are tightly abutted.
- ▶ Turn back the other half of the length(s), adhere and roll as necessary.

#### KEY POINT

Always trace and cut through in one direction for best results.

- ▶ Using a (correctly gauged) recess scribe position as necessary and scribe the overlapping sheet material. Run through the scribe with a sharp blade to ensure a clean cut.
- ▶ Roll the outer edge of the motif to ensure a good transfer is achieved.
- ▶ The Polyflor Design Service waterjet designs are maintained in the same manner as the surrounding Polyflor Vinyl floor covering.



Further information on maintenance can be found in Section fourteen.

### 10.7 INSTALLATION OF BORDERS

- ▶ Measure and mark the subfloor, using chalk lines to correspond with the required border positions. Measure the main lengths required to fit inside the border, allowing approximately 25mm overlap.
- ▶ Lay out the material so that it is overlapping the inner edge of the border chalk line.
- ▶ Snap the chalk line over the top of the material to correspond with the inner border lines.
- ▶ Using a knife and straight edge, carefully trace along the chalk lines and cut and remove the 25mm surplus. The material can now be folded back and adhered, taking care to retain a straight line around all outside edges. The area must then be rolled.
- ▶ The border pieces now require positioning up to the newly-cut straight edges, and adhering. The clear film on the face of the border design should then be removed and any minor adjustments to the border made whilst the adhesive is wet. The border can then be rolled.
- ▶ The outer margin can now be fitted and adhered to the finished border.



# RECOMMENDED FINISHES

The finishing details must be considered and agreed from the project outset to establish the individual areas of responsibility for all parties involved in the project.

## 11.1 INTRODUCTION

There are no short cuts to optimum performance with the installation of any flooring. An overview of each project right from the outset is essential to ensure finishing details are considered and agreed. This will also establish the individual areas of responsibility for all parties involved in the project.

There is no question that the final details contribute so much to an impressive finish for the floor. These include relatively minor details such as awkward corners, internal or external mitres, the junction where different floor coverings meet and finishing details around drains and other accessories. These make up only a small proportion of the total floor, yet they often make up most of an architect's snag list.

A Polyflor installation must focus on these important details and also take into account all aspects of the location. We believe that the floor must not only look good, but also perform well, so that it is impermeable, hygienic and safe.

## 11.2 DRAINAGE

The location of drains is important.

- ▶ As far as possible, they should be away from sources of vibration in order to reduce movement.
- ▶ To make leak detection easier locate away from beams, columns and walls.
- ▶ Drains should be close to the main spillage sources, when direct outlets from spillage sources are not possible.
- ▶ The floor gradient into the drain depends on the process, traffic volume and the surface texture of the floor covering.
- ▶ The drains used should be built to permit examination, cleaning and repair without these operations causing damage to the floor.

### 11.2.1 Shower Drains

Only drains which have been specifically designed for use with sheet vinyl floorings should be considered. Most of these drains have clamping rings, which ensure the watertight security which is essential where hygiene and safety are of primary importance.

These clamping rings ensure that the Polysafe floor covering is held securely in position and they prevent the ingress of water that could adversely affect the adhesion at this critical point.



Figure 11.1 Stainless steel drain prior to fitting vinyl clamping ring

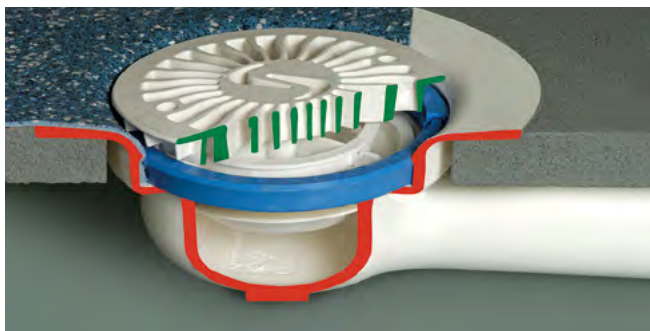

Figure 11.2 Drain with clamping ring in place

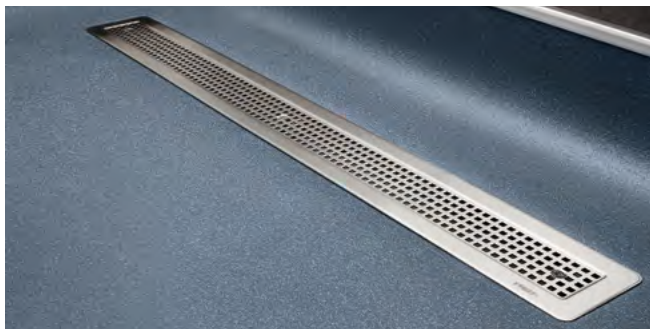

Figure 11.3 Linear Drain

### 11.2.2 Drainage channels and gullies

Again, only drainage channels and gullies which incorporate vinyl clamping and locking systems into their design should be considered.

### 11.3 CONSTRUCTION JOINT COVERS

Correct treatment at expansion joints is also essential if the floor is going to last and perform in a safe and hygienic manner. We recommend that expansion joints are covered using either a PVC expansion joint cover, or a cover with a PVC insert, so that the flooring can be thermally welded to the cover (Figure 11.4).

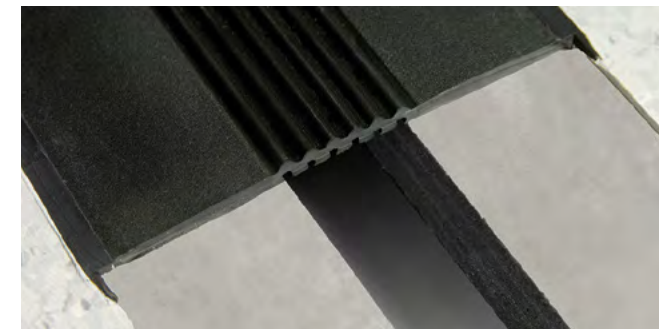

Figure 11.4 PVC expansion joint

#### KEY POINT

On no account must the Polyflor or Polysafe be taken straight over the expansion joint. This will lead to failure.

### 11.4 EDGE TRIMS

In many of the areas where Polyflor is installed, other types of floor covering will also be used. The junction between the Polyflor flooring and these other types of floor covering is a potential weak point, if not treated properly. Correct installation minimises problems such as water leakage and trip hazard.

#### 11.4.1 Polyflor or Polysafe with ceramic or quarry floor tiles

In installations where the edge of the vinyl comes into contact with ceramic or quarry tiles:

- ▶ Achieving a watertight joint at the junction is important.
- ▶ Aluminium edge trims with PVC inserts are ideal for this purpose. They facilitate installation and the PVC insert allows for a welded joint between the edge trim and the Polyflor floor covering.

#### 11.5 POLYFLOR WITH CARPET

- ▶ Ensure the junction between Polyflor and carpet is clearly visible.
- ▶ Minimise any trip hazard by using edging strips.
- ▶ A variety of edging strips are available for this junction. The relevant manufacturers can supply further advice on installation and use of these types of trims.

### 11.5.1 Bevelled and diminishing strips

- ▶ Bevelled or diminishing strips should be used at all exposed edges of Polyflor vinyl floorings to minimise trip hazards.
- ▶ The bevelled strip should be butted tightly to the exposed edge of the Polyflor vinyl flooring. The bevelled strip should be fixed using a contact adhesive and the joint may be thermally welded.

### 11.6 ACCESS AND MANHOLE COVERS

The use of access covers is important to facilitate either the welding of the Polyflor vinyl flooring to the cover and frame or where the Polyflor vinyl flooring can be clamped into place. Both these solutions result in a watertight, hygienic and safe joint.

### 11.7 INSTALLATION OF ACCESSORIES

The Polyflor Ejecta ranges of flooring accessories are PVC extrusions designed for use with most vinyl floor coverings, especially the Polyflor and Polysafe ranges.

The Ejecta range includes:

- ▶ Set-in coved skirtings
- ▶ Sit-on coved skirtings
- ▶ Cove former
- ▶ Capping strip
- ▶ CT strip
- ▶ Weld rods



For more information on weld rods refer to Section nine.

### 11.8 RECEIPT & STORAGE

On arrival at site, the accessories should be checked, stored and conditioned, together with the adhesive, as described for vinyl flooring.

**NOTE** Inflammable adhesives require special storage conditions. Contact adhesive manufacturer or refer to current literature for details.

### 11.9 PREPARATION

- ▶ Ensure that all surfaces are firm, dry and free of dust, grease and oil.
- ▶ Fair faced brickwork or block work should have a latex skim coat applied, as this provides a smooth, firm surface of known porosity which will minimise adhesive usage and improve adhesion.
- ▶ Alternatively, 5.5mm thick plywood can be cut into appropriate width

strips and then securely fixed to the block work to provide a smooth surface onto which the skirting can be fitted.

- ▶ All painted surfaces must be stripped back and wire brushed to remove all traces of paint.

**NOTE** Always read carefully and observe the instructions of the adhesive manufacturer. Paying particular attention to use of solvent-based adhesives, especially regarding ventilation and possible sources of ignition.

### 11.10 MARKING OUT

- ▶ Accurate marking out is essential to minimise adhesive usage and to prevent excess adhesive spoiling decorations.
- ▶ Marking out may be done by a variety of methods including scribes, height gauges and section templates.
- ▶ All fitting work must be carried out accurately prior to application of adhesive, as movement afterwards is restricted.
- ▶ Adjustments for length should always be made on straight joints – never on mitred sections – unless the length of the wall does not permit this.
- ▶ When using sit-on coved skirtings around external corners, a joint can be avoided by grooving out some of the material from the back using an Exacto cutter, and then warming the coving with a hot air gun. It should be noted that the toe will be curved rather than right angled when the coved skirting is installed.

### 11.11 ADHESIVE APPLICATION

#### KEY POINT

For use in well ventilated areas where there is no risk of ignition of the organic vapours.

This system is based upon a solution of polychloroprene rubber in organic solvents. The application is as follows:

- ▶ If the surface is slightly porous, apply a suitable primer and leave to dry.
- ▶ Apply adhesive equally to the section and to the surface to which it will be attached, using a suitable applicator. Leave until the adhesive is dry to the touch.
- ▶ As a guide, adhesive coverage should be approximately 5 litres per 100 metres on 100mm high Ejecta section, dependent upon the porosity of the surface and the thickness of applied coats.

### 11.12 ADHERING THE ACCESSORIES

- ▶ When the adhesive is dry to the touch, press the section firmly against the other surface, placing it accurately first time.



- ▶ The section should not be removed or subjected to lateral force if good adhesion is to be assured.
- ▶ Set-in covered skirtings are applied before the floor finish is laid and sit-on covered skirtings are applied after the floor finish is laid.

### 11.13 SKIRTINGS AND OTHER FINISHES

Polyflor supplies a wide range of PVC profiles which are ideal for use with the Polyflor range of products. In most installations, we would recommend that the Polyflor vinyl flooring is either site-covered up the wall, or a 'set in' covered skirting is used which can be welded to the Polyflor vinyl flooring.

#### 11.13.1 Site coving

Polyflor Ejecta CT strip (Figure 11.4 and 11.5) provides the ideal solution for the junction between site-covered Polyflor vinyl flooring and ceramic wall tiles.

The flexible section is designed to accept ceramic wall tiles on one side and the various gauges of Polyflor on the other.



Figure 11.4 Polyflor Ejecta CT Strip

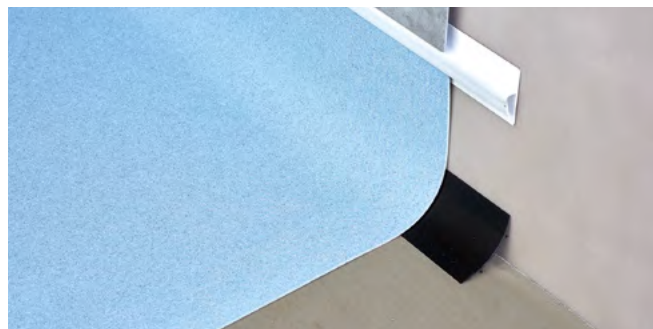

Figure 11.5 Polyflor Ejecta CT Strip

Practise  
Capping &  
Coving techniques  
on the 3 & 4 day  
Polyflor Floor  
Laying Courses

#### 11.13.2 Set-in covered skirtings

Where the use of the site-covered method of installation is impractical or is not cost effective, the Polyflor Ejecta set-in skirting (Figure 11.6) is a viable alternative.

Very similar to the sit-on type skirting in appearance, the set in skirting has a 50mm toe which is adhered to the subfloor and allows the main field of sheet vinyl to be welded to it.

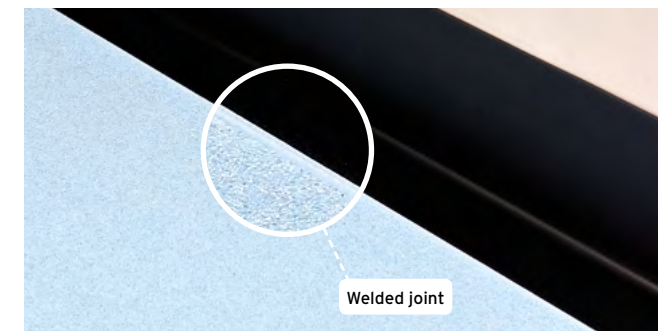

Figure 11.6 Set-in covered skirting

#### 11.14 SIT-ON SKIRTINGS

Sit-on skirting (Figure 11.7) generally tend only to be used in conjunction with tiled floors to provide a finish around the perimeter of the room. The sit-on skirting is adhered to the walls and the toe of the skirting sits on top of the floor; it is not welded. If requested suitable mastic sealant can be used beneath the toe of the skirting.



Figure 11.7 Sit-on covered skirting

#### 11.15 MASTIC SEALANT FINISH

When specified suitable silicone mastics can be used as a finish around the perimeter of a room. This is provided a water tight finish is not required and all parties are in agreement as to this type of finish.

# RESISTANCE TO CHEMICALS

An overview of the general chemical resistance of Polyflor Vinyl Flooring.

## 12.1 POLYFLOR VINYL FLOORING

Polyflor and Polysafe vinyl floor coverings features include:

- ▶ An above average resistance to mild and dilute acids, alkalis, soaps and detergents.
- ▶ Unharmed by petrol and strong acids, provided any spillage is cleaned off immediately.
- ▶ Should not be allowed to come into contact with Ketones, chlorinated solvents, acetone and similar solvents; however, should this happen, the effect can be minimised. Remove the spillage immediately, then leave any solvent residue to evaporate, prior to allowing any footfall.
- ▶ Are suitable for use in all areas where most chemicals are used and there is only risk of accidental spillage; however some chemicals contain very strong dyes that, even after a short period of contact, will stain the vinyl flooring. In areas where such chemicals are used selecting an appropriate dark colour can minimise the staining effect.

### IMPORTANT NOTE

Polyflor test for resistance to chemicals is evaluated over a 24 hour contact period at a room temperature of 21°C, followed by rinsing with cold water. Polyflor believes this simulates the worst situation where spillages are not removed immediately and are only cleaned by normal maintenance. Some stains can be removed by abrading with a nylon pad during maintenance. A metallised emulsion floor polish can be used as a sacrificial layer for protecting the floor against staining.

Where specific chemicals are used - for instance in a photographic laboratory - a set of chemical resistance charts is available on request. These charts show the resistance to a range of specific chemicals by shade for each Polyflor product, and will prove helpful in selecting colours which are least affected by specific chemicals.

## 12.2 GENERAL CHEMICAL RESISTANCE OF POLYFLOR VINYL FLOORING

ORGANIC LIQUIDS	EFFECT	ACTION
Aldehydes Esters Halogenated hydrocarbons Ketones	Flooring attack occurs after several minutes.	Wipe up immediately.
Alcohols Ethers Glycols Hydrocarbons (aromatic & aliphatic) Petroleum spirit Vegetable oil	After several days, plasticiser extraction occurs, with associated problems of shrinkage and embrittlement.	Wipe up immediately.
AQUEOUS SOLUTIONS	EFFECT	ACTION
Mild acids and alkalis	No effect.	
Strong alkalis	Will strip polish and may cause discolouration in some shades.	Dilute and remove.
Strong acids	Prolonged contact can cause discolouration.	Dilute and remove immediately.
Dyes (indicators)	Contact can cause discolouration.	Dilute and remove immediately.

## 12.3 POLYFLOR RUBBER FLOOR COVERINGS

Polyflor Rubber floor coverings have average resistance to mild and dilute acids, alkalis, soaps and detergents. Prolonged exposure to petrol, oils, greases and fats will cause softening and swelling. Polyflor Rubber floor coverings are **unsuitable** for garage workshops or food preparation areas, but are suitable for areas where spillage is infrequent. Occasional, accidental spillages, which are removed immediately, do not normally damage the flooring. A comprehensive guide to chemical effects and staining by product shade is available on request.

## 12.4 REACTION TO RUBBER

Antioxidants used in the manufacture of rubber can cause staining. Non-rubber traffic mats are recommended, as are tyre trays for car showrooms, etc. Using black or dark brown floor coverings will not prevent staining but will disguise it. Lighter coloured rubber can also be specified for appliance feet, trolley wheels etc.

## 12.5 ALCO-BASED HAND GELS

Polyflor homogeneous PUR, heterogeneous PUR and Polysafe safety flooring ranges are compatible for use with the most commonly used alco-based hand gels. Some alco-based hand gels contain a high concentration of ethanol and to discuss their compatibility with other Polyflor floor coverings, contact **Polyflor Customer Technical Services Department (CTSD)** on +44 (0) 161 767 1912.

# OPERATING TEMPERATURES

An overview of operating temperatures and Polyflor Vinyl Flooring.

## 13.1 OVERVIEW

The full range of Polyflor and Polysafe sheet vinyl floor coverings can be used under a wide range of service temperatures.

**Maximum upper temperature 60°C (140°F)**

**Minimum lower temperature -20°C (-4°F)**

Use in such extreme conditions is dependent upon the correct selection of adhesive. Guidance should be sought from the adhesive manufacturer for approval of the adhesive at the expected temperatures. Typically, an approved two-part epoxy or polyurethane adhesive should be used in the main field, and a contact adhesive for vertical applications.

It is important that the materials be conditioned and installed at normal room temperatures: 18°C (65°F). The material should be fully adhered to the substrate, taking care to ensure that there are no unsupported voids beneath the vinyl. In these types of installation, and where site coving is specified, then a pencil cove should be used, and not one with a cove former. All joints should be hot welded 24 hours after installation and before the installation is taken to the service temperature.

Polyflor and Polysafe ranges can both withstand occasional sudden changes in temperature caused by short-term contact with hot water and steam. Long-term or regular contact should be avoided. Where there is a possibility of regular contact with liquid gases, which are extremely cold, the constant expansion and contraction of the vinyl may cause premature failure. In these instances, laying a second piece of vinyl loose laid on top of the floor as protection can be beneficial. This can be easily and economically replaced should it be damaged.

## 13.2 UNDERFLOOR HEATING

All Polyflor and Polysafe vinyl product ranges can be installed over underfloor heating, with the following recommendations:

- ▶ The system should be fully tested and commissioned prior to the flooring installation commencing to ensure the heating system is operating correctly.
- ▶ Underfloor Heating systems should be switched off and be fully cooled for a minimum of 48 hours prior to the installation commencing. The system should remain off and fully cooled during the installation and for a minimum of 48 hours afterwards. It should then be slowly brought back up to the working temperature incrementally over several days.
- ▶ A maximum subfloor temperature; (at the adhesive line) of 27°C should never be exceeded.
- ▶ Specialist high temperature adhesives should be used in areas with underfloor heating, direct sunlight, and areas of high solar gain. Please refer to the Polyflor Approved Adhesive List or contact your adhesive manufacturer for more information.

## 13.3 AREAS SUBJECTED TO PROLONGED SUNLIGHT

### KEY POINT

Polyflor floor coverings are designed for **internal** usage only. We cannot guarantee the performance of any of our floor coverings in external environments.

Large, sun-facing windows (especially where under-floor heating is in use) and conservatories can experience problems due to high daytime temperatures and low night-time temperatures.

- ▶ Ensure that an even day and night temperature is maintained during the laying period and until the adhesive reaches its full bond strength, which is normally three days.
- ▶ To achieve the best results, shade all windows, turn off any underfloor heating, provide background heating at 18°C and select an epoxy or polyurethane grade adhesive.
- ▶ Condition the tiles correctly prior to installation. Polyflor will not accept responsibility for any expansion or shrinkage problems, which may result from changes in temperature during the period when the adhesive is reaching full bond strength.

## 13.4 PROTECTION FROM RADIATED HEAT SOURCES

The Polysafe range of floor coverings is often specified in situations where excessive heat causes problems with the floor covering and the adhesive. It is impractical to give specific details, as equipment such as ovens and kilns vary in design and height above the flooring material.

Where the conditions may cause a problem, we would recommend the use of metal trays to deflect the heat away from the floor, and an adhesive suitable for these conditions, such as an epoxy or polyurethane. If you are unsure, we recommend that you discuss the application with the **Polyflor Customer Technical Services Department (CTSD) on +44 (0) 161 767 1912.**

# FLOOR CARE & MAINTENANCE

Achieve the installation's optimum performance by selecting and implementing the most appropriate maintenance programme.

## 14.1 INTRODUCTION TO MAINTENANCE

### 14.1.1 Why is floor care necessary?

Floor coverings are selected for many reasons including their colour, design and sometimes specialist properties such as static control or slip resistance. Without regular maintenance:

- ▶ Dust and soiling would soon build up, making the colour and design indistinguishable and the specialist properties practically useless.
- ▶ Dirt and soiling can also harbour bacteria, making the floor covering a health hazard e.g. in hospitals or food processing areas.
- ▶ Dust and grit underfoot can also act as an abrasive, which, if left uncontrolled, would shorten the life of a floor covering, causing premature replacement.

Regular and well planned maintenance keeps the floor covering in pristine condition and can enhance the original appearance. Maintenance can also reduce wear and ultimately improve the life expectancy of the floor covering.

### 14.1.2 What is maintenance?

Maintenance means many things to many people. To some, it is an army of operatives using powered machines working to a comprehensive maintenance programme. To others, it is a person who comes in three evenings a week to dust and mop the floors. In each case, the requirement for cleanliness can be completely different.

This variability in what is considered 'normal' makes it impracticable in this manual to give precise maintenance instructions to suit specific end user locations. The instructions given are intended to be used as a guide. A guide based on general experience using established methods and cleaning materials. Polyflor recommends that the instructions are followed initially and, as traffic patterns become established, the frequency is tailored to suit individual requirements.

### 14.1.3 Tailored Maintenance

#### KEY POINT

Cleaning and disinfecting are entirely separate processes and should be treated as such in tailored maintenance programmes. Refer to section 14.3.3 for disinfecting.

Reducing maintenance costs is not difficult; what takes much more skill is reducing these costs without cutting the effectiveness of the maintenance system. By tailoring a maintenance programme, real savings can be made without compromising standards of appearance, hygiene and cleanliness.

Tailored maintenance programme are simple to apply, with the effort and thus the cost, concentrated where each location demands. The benefits are definite savings and considerable return on any floor covering investment.



Certain Polyflor ranges benefit from enhanced formulations in relation to maintenance. The PUR family provides long term maintenance benefits. The PU family facilitates a reduction in the intensity of the construction clean and provides the foundation for the ongoing maintenance regime.

In our experience, a tailored maintenance approach is the best solution for all types of floor coverings.

**CLEANING & MAINTENANCE TRAINING COURSES**  
 The courses, that include both practical and theory work, have been developed to help facilities management staff get the best from Polyflor Vinyl floor coverings by using the correct cleaning methods and products.  
 For further information email [trainingschool@polyflor.com](mailto:trainingschool@polyflor.com)

**14.1.4 The Polyflor in-depth approach**

We begin by looking at the many variables which have a part to play in maintenance. These include floor location, type and quantity of traffic, and the existence or otherwise of dirt barriers. Armed with this information, a solution which gives real savings without affecting the floor’s appearance, hygiene or cleanliness can be developed.

**14.2 POINTS TO CONSIDER**

Before establishing a maintenance programme, there are some points which should be considered, as they can affect the method and frequency – and hence the cost – of maintenance.

**14.2.1 Dirt Barrier Systems**

Evidence from a wide range of studies indicates that up to 80% of all dirt, grit and moisture is carried into a building by the people using it. One of the easiest ways to reduce maintenance costs must therefore be to reduce the amount of dirt, grit and moisture they bring in. Not only would this cut the cost of its removal, but it would also cause less abrasive action on the floor covering, which in turn would ensure a longer useful life. With less moisture, there would also be less potential for slipping.

Unfortunately, notices asking people to thoroughly wipe their feet rarely work. What is needed is an effective ‘passive’ dirt barrier system. At first, these systems can seem expensive but the savings they provide over the long term are substantial.

An effective dirt barrier system has both scraping and absorbing qualities and is sufficiently large to perform these actions on both feet during normal walking – hence ‘passive’. Dirt barrier systems should be considered early in the specification stage. They should not be an afterthought, when there are rarely sufficient funds or space to do the job properly.

**14.2.2 The Ideal Dirt Barrier**

- ▶ An exterior scraper mat at least two paces wide, set into a mat well. The choice of materials is varied. Clearance should be sufficient to allow grit and debris to fall below. Also allowances must be made for the wearers of various types of shoes.
- ▶ An interior grade combination scraper/moisture mat of two to three metres in length. This will remove the majority of moisture and any fine abrasive particles. This can also be set into a mat well. Again, the choice of materials is wide and often the barrier will be a composite of several materials.



**NOTE** To maintain the effectiveness of dirt barrier systems, they must be cleaned regularly, otherwise they can actually increase the soil intake by creating a ‘soil reservoir’ at the entrance to the building.

**14.3 ASSESSING THE LOCATION**

As mentioned earlier, by tailoring the maintenance programme, real and achievable savings can be made without compromising standards of appearance, hygiene and cleanliness. The first part of this process is to break down areas to be cleaned into a series of independent locations. Each location should then be assessed before a particular maintenance regime is employed to provide a clear indication as to where the effort and therefore the cost should best be applied.

These assessments should be reviewed periodically, to ensure that standards are to the level expected by the client and that cost savings are being achieved wherever this is possible.

### 14.3.1 Points to consider

The assessment should consider the following points:

#### Location

Position of the location in the building. Entrance areas and receptions will require more intensive, frequent cleaning than upper floor, low circulation corridors.

#### Soiling

Type of soiling which is likely to be found in the location. Dirt and grit from an outside car park will require a different treatment from chemical spillage in a laboratory.

#### Client Expectations

The expectation of the client for that particular location plays an important part. Obviously, if a high level of hygiene is required, the maintenance regime must be able to provide this.

#### Traffic

Traffic types, density and frequency in the given location. The type of footwear used by children in school corridors provides a different situation from that where soft soled trainers or pumps are used in the school sports hall.

#### Type Of Cleaning Equipment

Manual methods can be time consuming in large areas and may be incompatible with the frequency requirement. However, large machines used in confined spaces can take longer than manual methods.

#### Colour Of Floor Covering

In general, light colours show soiling more easily, dark colours show loss of gloss more easily. Mid range colours will give a balance between the two extremes.

#### Prevailing Weather

In icy conditions, grit and salt are sometimes used outside building entrances. In dry conditions, dust and sand can also be found outside buildings. In both instances, soiling and abrasion can be accelerated if effective measures are not taken to prevent them being trafficked into the building.

### 14.3.2 The Assessment should establish the following:

- The type of cleaning needed
- The frequency of cleaning
- The cleaning products and equipment needed
- The level of labour required
- The time to be allocated

### 14.3.3 Disinfecting Polyflor Floors

**SPECIAL PRECAUTIONS**  
Never allow Chlorhexidine based disinfectants (scrub hand gels) to come into contact with chlorinated products, any surface will stain immediately.

All cleaning and disinfecting products should be used in accordance with the manufacturers' instructions. Disinfection and cleaning are two different processes and require two separate procedures.

#### Cleaning

Follow Polyflor's floor cleaning recommendations as detailed in sections 14.5 – 14.11.

#### Disinfection

- ▶ The floor should be cleaned before disinfection.
- ▶ The floor should be neutralised before disinfection as some cleaning compounds can significantly affect the effectiveness of the disinfecting product.
- ▶ Floors should be rinsed and neutralised after disinfection and should always be dried. Floors that have a wet residue of a disinfecting solution may have a substance on the surface that is potentially corrosive not only to the floor covering but also to the soles of any footwear. The disinfecting solution may break down the shoe sole material to leave an ingrained stain on the floor. This stain may extend beyond the area being disinfected as the wet shoe sole will traffic the solution onto an adjacent dry area.
- ▶ Leaving a chlorinated disinfecting solution to dry out on floors may make them slippery. The dried chlorine salts leave small particles on the surface of the floor which may act like small ball bearings.
- ▶ RINSE floor after disinfecting to neutralise.
- ▶ Chlorine based disinfecting products can be used on Polyflor vinyl floor coverings provided that they are used and diluted as per the manufacturer's instructions and that the area is effectively rinsed after their use.

### 14.4 INDIVIDUAL PRODUCT MAINTENANCE PROCEDURES

As the Polyflor product portfolio has developed, the maintenance procedures have become specific to generic types which are:

- 14.5** Smooth products with PUR (polyurethane reinforcement)
- 14.6** Smooth products with PU (polyurethane surface treatment)
- 14.7** Smooth products without PUR or PU
- 14.8** Polysafe products with PUR
- 14.9** Polysafe Barefoot & Shod products – Wetroom Floorcare
- 14.10** Polysafe products without PUR
- 14.11** ESD ranges where no polish should be applied
- 14.12** Rubber floor coverings

The general maintenance procedures are listed in the subsequent pages. Individual floor cleaning guides to aid the end user or maintenance staff are also available on request or online at polyflor.com.

### 14.5 STANDARD SMOOTH VINYL WITH PUR

The Polyflor PUR family of products incorporates a polyurethane reinforcement, which protects the floor covering by resisting soiling and scuffing. Combined with the superior closed surface finish, this enhanced protection allows the use of a polish-free maintenance regime. This protection ensures that the intensity of the maintenance and overall cleaning costs are significantly reduced.



The following maintenance instructions are designed to maximise the benefits of the PUR, resulting in lower maintenance costs, without compromising the long-term appearance of your floor covering.

#### 14.5.1 Initial construction clean

- ▶ Remove all loose debris.
- ▶ Ensure that all traces of adhesive are removed from the surface of the floor covering.
- ▶ Mop sweep or vacuum to remove dust and grit.



Figure 14.1 Microfibre mop pad with dual bucket system

#### 14.5.2 Routine maintenance

- ▶ Damp mop with a neutral detergent.
- ▶ If required, dry buff with a 1000 rpm plus rotary machine fitted with a suitable clean pad.

The following recommendations are provided as a guideline, and the frequency can be changed to optimise the appearance.

##### Daily

Mop, sweep or vacuum to remove dust and loose dirt. If required, spot mop to remove stubborn marks, with a neutral cleanser.

##### Weekly

Assess the appearance of the floor. Undertake the following as required: Light scuffing – dry buff with a 1000 rpm plus rotary machine fitted with a suitable clean pad.

##### Or

Heavier scuffing – spray clean using a floor maintainer and 1000 rpm plus rotary machine fitted with a suitable clean pad.

#### 14.5.3 Periodic Maintenance

- ▶ Assess the appearance of the floor. If the floor has dirt build-up, machine scrub with a scrubber dryer (approx. 165 rpm) fitted with a suitable clean pad, using a neutral or alkaline detergent, as appropriate.
- ▶ Rinse thoroughly and allow to dry. Dry buff to restore finish.

#### 14.5.4 Additional Information

- ▶ The maintenance regime requires the installation of an effective barrier matting system.
- ▶ The cleaners and detergents should be diluted as per the manufacturers' instructions.
- ▶ Always follow the Health and Safety guidance provided.
- ▶ Fit protective feet to table and chair legs, to prevent scratching.
- ▶ These maintenance instructions are intended for the PUR family of floor coverings, which have a polyurethane reinforcement. For other Polyflor products, reference should be made to the relevant section or to their specific cleaning guides.
- ▶ In most instances, the above maintenance regime will be sufficient to ensure your floor covering retains the optimum appearance. However where there is no mechanical means of maintaining the floor, an emulsion floor polish should be applied. Details of the procedure to be used can be found under the Standard Vinyl with PU – Section 14.6.3.
- ▶ Regular cleaning is more beneficial to the floor covering and more cost-effective than occasional heavy cleaning.

## 14.6 STANDARD SMOOTH VINYL WITH PU

Polyflor smooth vinyl 'PU' floor coverings incorporate a polyurethane surface treatment, which protects the floor covering by resisting soiling and scuffing. This protection facilitates a reduction in the intensity of the construction clean and provides the foundation for the ongoing maintenance regime. This easier cleanability offers maintenance cost savings when compared with non-treated materials.



The following maintenance instructions are designed to minimise the cost factor, without compromising the long-term appearance of your floor covering.

### 14.6.1 Initial construction clean

- ▶ Remove all loose debris.
- ▶ Ensure that all traces of adhesive are removed from the surface of the floor covering.
- ▶ Mop, sweep or vacuum to remove dust and grit.
- ▶ Damp mop with a neutral detergent.
- ▶ If required, dry buff with a 1000 rpm plus rotary machine fitted with a suitable clean pad.

### 14.6.2 Routine maintenance

The following recommendations are provided as a guideline, and the frequencies can be changed to optimise the appearance.

#### Daily

Mop, sweep or vacuum to remove dust and loose dirt. If required, spot clean to remove stubborn marks with a neutral cleanser. If required, dry buff to restore finish.

#### Weekly/Monthly

Assess the appearance of the floor. If required, scrub with a scrubber dryer fitted with suitable pads, and using neutral cleanser (pH 7 to 9). If required, dry buff to restore finish.

### 14.6.3 Application of a floor dressing

The Polyurethane surface treatment will provide initial protection for the floor covering. However, an application of a metallised polish may be required eventually to provide extra protection. The level and intensity of traffic and soiling will determine how soon the polish will have to be applied.

For polish free maintenance, see the Polyflor PUR range of products. For polish application, please follow details of the procedure below.

- ▶ Using an applicator and tray, or Kentucky mop with wringer and bucket, the first coat should be applied thinly and evenly across the floor, to within 150mm of the skirting. It should then be left to dry. This normally takes approximately thirty minutes, depending on the ambient conditions and the thickness of the coating.
- ▶ When the first coat is dry, a second coat should be applied at right angles to the direction of the first. Subsequent coats should be applied at right angles, and the final coat should be applied right up to the skirting.
- ▶ Two to three thin coats are usually sufficient to provide excellent resistance to abrasion, scuffing and removal of black heel marking. However, be guided by your own periodic assessments for the particular location.
- ▶ In order to minimise costs, subsequent polish applications may be applied only to traffic paths.
- ▶ Periodically - generally every six months - assess the appearance of the floor. If there is an unacceptable build-up of polish, this should be stripped and reapplied, as per the instructions above.

### 14.6.4 Additional Information:

- ▶ The maintenance regime requires the installation of an effective barrier matting system.
- ▶ The cleaners and detergents should be diluted as per the manufacturers' instructions.
- ▶ These maintenance instructions are intended for the Polyflor 'PU' family, which incorporates a polyurethane surface treatment. For other Polyflor products, reference should be made to the relevant section or to their specific floor care sheets.
- ▶ For further guidance, contact **Polyflor Customer Technical Services Department (CTSD)** on +44 (0) 161 767 1912.
- ▶ Always follow the Health and Safety guidance provided.
- ▶ Regular cleaning is more beneficial to the floor covering and more cost-effective than occasional heavy cleaning.



## 14.7 STANDARD SMOOTH VINYL RANGES WITHOUT PU OR PUR

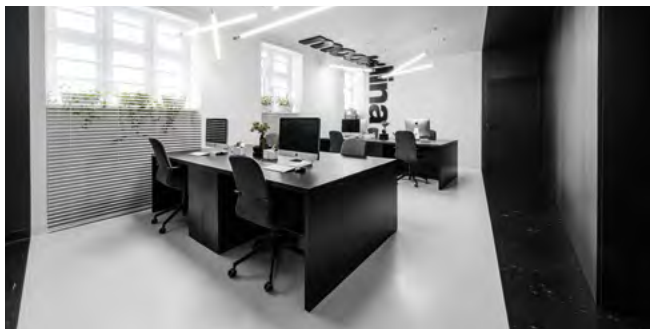

### 14.7.1 Initial construction clean

- ▶ Sweep, mop sweep or dry vacuum the floor, to remove dust, grit and debris.
- ▶ For light soiling  
Damp mop the floor with a neutral cleanser diluted to the manufacturer's instructions.

Or

- ▶ For heavy soiling  
Apply a solution of alkaline cleanser, diluted to the manufacturer's instructions, to the floor and leave for sufficient time to react with the soiling. Using a 165 to 350 rpm rotary machine fitted with a scrubbing pad, machine scrub the floor and then pick up the slurry with a wet vacuum. Rinse the floor thoroughly with clean warm water, pick up with a wet vacuum and leave to dry thoroughly.

### 14.7.2 Application of a floor dressing

Ensure that there is a good key between the floor dressing and the surface of the flooring, scrubbing the floor if required. Either of the following methods can be used:

Emulsion Polish

Apply two or three thin coats of emulsion polish in accordance with the manufacturer's instructions, with either a proprietary polish applicator or Kentucky mop wrung out to prevent over-application of polish. The polish should be applied up to 150mm from the edges of the room, and subsequent coats should be applied at 90° to the previous one. The final coat should be applied right up to the edges of the room.

Or

Spray Clean/Polish

To enable a protective film to develop as quickly as possible, the floor maintainer should be used undiluted for the first 2-3 applications, and, thereafter, in accordance with the manufacturer's instructions.

### 14.7.3 Routine maintenance

**NOTE** To provide adequate protection in high traffic areas, applying an emulsion polish can be more effective than spray clean/polish. Where a high shine finish is undesirable, a satin finish polish should be used.

The frequency of each of the operations is dependent upon the type and intensity of traffic.

- ▶ Sweep, mop sweep or dry vacuum the floor, to remove dust and loose dirt.
- ▶ Spot mop frequently. Stubborn black marks can be removed by using the centre disc of a scrubbing pad and a small amount of undiluted alkaline cleanser. Place the disc under the sole of the shoe and rub; this gives greater pressure.
- ▶ Rinse the area well with clean warm water and leave to dry.

Depending upon the end user requirement and the equipment available, one of the following methods should be used:

- ▶ Using floor maintainer, diluted to the manufacturer's instructions, mop the floor and leave to dry.
- ▶ If a shine is required, the floor should be buffed with a 500 to 2000 rpm rotary machine fitted with a suitable pad.

Or

- ▶ Using floor maintainer, diluted to the manufacturer's instructions, spray a fine mist onto the floor. Using a 165 to 500 rpm rotary machine and suitable spray cleaning pad, buff the floor to the desired shine. The dirt is picked up in the pad, which should be thoroughly cleaned after use. Failure to do so will result in a shiny, dirty floor.

Or

- ▶ Using a neutral or germicidal cleanser, diluted to the manufacturer's instructions, mop the floor and allow to dry completely. Using a 500 to 2000 rpm rotary machine, buff the floor to the desired level of shine.

#### KEY POINT

When high speed burnishing, it is important that the machine is kept constantly moving. This avoids excessive heat build-up on the floor. As an additional precaution, we advise that a spray of clean water is used, to help lubricate the pad.

### 14.7.4 Removal of a floor dressing

An unsightly build-up of polish should be avoided. The polish should be removed regularly – the interval between application and removal depends on the wear conditions and the number of polish layers (normally six months in heavy traffic areas).

Follow the manufacturer's instructions.

### 14.7.5 Additional Information

Always follow the Health and Safety guidance provided. Regular cleaning is more beneficial to the floor covering and more cost-effective than occasional heavy cleaning.

## 14.8 POLYSAFE RANGES WITH PUR



The following maintenance instructions are designed to minimise the cost factor, while ensuring that your floor covering retains the optimum appearance and performance. The exclusive Polysafe PUR system reduces the intensity of cleaning and the use of chemicals, which helps minimise the effect on the environment, without compromising such key elements as hygiene and underfoot safety.

### 14.8.1 Construction clean

Polysafe PUR is designed to resist soiling, which ensures that - even after transportation, installation and the period prior to handover - the intensity of construction clean can be significantly reduced. This will have a beneficial impact on the initial costs.

- ▶ Remove all loose debris.
- ▶ Remove surface dust and grit by sweeping or vacuuming.
- ▶ Apply a solution of neutral cleanser (or alkaline cleanser, dependent upon the level of soiling), diluted to the manufacturer's instructions, with a spray over the section to be cleaned. Leave for sufficient time to react with the soiling.
- ▶ Pick up the solution with a clean microfibre mop, using a continuous side-to-side motion. When the mop head becomes loaded, it will start streaking the floor. At this point, the dirty mop head should be removed and placed into a laundry bag and a clean mop head fitted. The cycle should then be repeated until the whole floor is completed.
- ▶ Launder the dirty mop heads in preparation for reuse.

**NOTE** For floor with heavy scuffing, it may be necessary to use a Doodle bug or similar tool fitted with a suitable pad to remove the scuff marks.

### 14.8.2 Daily maintenance

- ▶ Remove surface dust and grit by sweeping or vacuuming.
- ▶ Apply a solution of neutral cleanser (or alkaline cleanser, dependent upon the level of grease or oily contaminants), diluted to the manufacturer's instructions, with a spray over the section to be cleaned. Leave for sufficient time to react with the soiling.
- ▶ Pick up the solution with a clean microfibre mop, using a continuous side-to-side motion. When the mop head becomes loaded, it will start streaking the floor. At this point, the dirty mop head should be removed and placed into a laundry bag and a clean mop head fitted. The cycle should then be repeated until the whole floor is completed.



Figure 14.2 Safety mop pad with dual bucket system

- ▶ Launder the dirty mop heads in preparation for reuse.
- ▶ Where detergent residue remains on the floor surface, the area should be rinsed completely with clean, warm water, picked up with a wet vacuum and left to dry thoroughly.
- ▶ In areas subject to heavy soiling, machine scrubbing should be undertaken on a periodic basis, after neutral or alkaline cleanser has been applied to the floor, diluted to the manufacturers' instructions.

### 14.8.3 Additional Information

- ▶ This maintenance procedure has been designed to optimise the benefits of the Polysafe PUR system – the latest in proven cleaning technology. The maximum benefits are derived from this system by carrying out this quick and simple procedure on a daily basis, and by using clean equipment each time, to maximise dirt pick-up and eliminate streaking.
- ▶ A floor dressing or maintainer containing polish should **not** be applied to Polysafe ranges with PUR, as this may impair the slip resistance. If in doubt, consult Polyflor CTSD on +44 (0) 161 767 1912.

- ▶ Always follow the Health and Safety guidance provided.
- ▶ Regular cleaning is more beneficial to the floor covering and more cost-effective than occasional heavy cleaning.
- ▶ The cleaners and detergents should be diluted as per the manufacturers' instructions. For recommended products, see the Polyflor Approved Maintenance Products sheet located within the Technical section of polyflor.com
- ▶ Polysafe safety flooring ranges are compatible for use with the most commonly used alco-based hand gels and are suitable for steam cleaning on a periodic basis.

All the above methods of maintenance are suitable to be applied to Polysafe PUR ranges.

### 14.9 POLYSAFE BAREFOOT & SHOD SAFETY FLOORING (WET ROOMS)



#### 14.9.1 Manual Cleaning

- ▶ Sweep, mop sweep or dry vacuum to remove dust and loose dirt.
- ▶ Spot scrub regularly with a deck scrubber.
- ▶ Apply a solution of neutral or alkaline cleanser, diluted to the manufacturer's instructions, to the floor and leave for sufficient time to react with the soiling.
- ▶ Pick up the slurry with a clean microfibre mop, using a continuous side-to-side motion. When the mop head becomes loaded, it will start streaking the floor. At this point the dirty mop head should be removed and placed into a laundry bag and a clean mop head fitted. The cycle should then be repeated until the whole floor is completed.
- ▶ The dirty mop heads should be laundered, in preparation for reuse.
- ▶ Where detergent residue remains on the floor surface, the area should be rinsed completely with clean, warm water, picked up with a wet vacuum and left to dry thoroughly.

### 14.9.2 Machine Cleaning

- ▶ Sweep, mop sweep or dry vacuum to remove dust and loose dirt.
- ▶ Using a scrubbing brush or a cylindrical type scrubbing machine.
- ▶ Apply a solution of neutral or alkaline cleanser, diluted to the manufacturer's instructions, to the floor and leave for sufficient time to react with the soiling. Using a 165 rpm rotary machine fitted with a bristle brush, cylindrical machine or deck scrubber, scrub the floor and then pick up the slurry with a wet vacuum. Rinse thoroughly with clean, warm water, pick up with a wet vacuum and leave to dry thoroughly. Using a 165 rpm rotary machine fitted with a bristle brush, cylindrical machine or deck scrubber, scrub the floor and pick up the slurry with a wet vacuum. Rinse thoroughly with clean, warm water, pick up with a wet vacuum and allow to dry thoroughly.

### 14.10 POLYSAFE RANGES WITHOUT PUR



#### 14.10.1 Construction clean

**POLYSAFE**  
For Barefoot & Shod Safety Flooring replace the scrubbing pad with a rotary scrubbing brush or a cylindrical type scrubbing machine.

- ▶ Sweep, mop sweep or dry vacuum the floor to remove dust, grit and debris.
- ▶ Apply a solution of alkaline cleanser, diluted to the manufacturer's instructions, to the floor and leave for sufficient time to react with the soiling.
- ▶ Using a 165 rpm rotary machine fitted with a scrubbing pad, machine scrub the floor and then pick up the slurry with a wet vacuum.
- ▶ Rinse the floor thoroughly with clean warm water, pick up with a wet vacuum and leave to dry thoroughly.
- ▶ For small areas, where there is no suitable scrubbing machine available, a deck scrubber should be used in conjunction with a wet vacuum or mop and bucket system.

- ▶ Dilution rates above the manufacturer's minimum recommendations may be necessary for very heavy soiling.

#### 14.10.2 Ongoing maintenance

For ongoing maintenance, the frequency of each of the operations is dependent upon the type and intensity of traffic as well as the appearance expectations and should be adjusted to suit.

#### 14.10.3 Standard surface finish

- ▶ Sweep, mop sweep or dry vacuum the floor, to remove dust and loose dirt.
- ▶ Spot mop regularly. Stubborn black marks can be removed by using the centre disc of a scrubbing pad and a small amount of undiluted alkaline cleanser. Place the disc under the sole of the shoe and rub; this gives greater pressure. Rinse the area well with clean warm water and leave to dry.
- ▶ Apply a solution of neutral or alkaline cleanser, diluted to the manufacturer's instructions, to the floor and leave for sufficient time to react with the soiling. Using a 165 rpm rotary machine fitted with a scrubbing pad, machine scrub the floor and then pick up the slurry with a wet vacuum. Rinse thoroughly with clean, warm water, pick up with a wet vacuum and leave to dry thoroughly.

#### 14.10.4 Additional Information

- ▶ A floor dressing should not be applied to Polysafe floor coverings, as this may impair the slip resistance. If in doubt, consult **Polyflor CTSD** on +44 (0) 161 767 1912.
- ▶ Always follow the Health and Safety guidance provided.
- ▶ Regular cleaning is more beneficial to the floor covering and more cost-effective than occasional heavy cleaning.
- ▶ The cleaners and detergents should be diluted as per the manufacturer's instructions. For recommended products, see the Polyflor Approved Maintenance Products sheet located within the Technical section of polyflor.com
- ▶ Polysafe safety flooring ranges are compatible for use with the most commonly used alco-based hand gels and are suitable for steam cleaning on a periodic basis.

### 14.11 ELECTRO STATIC DISSIPATIVE (ESD)

The ESD family of vinyl floor coverings are designed to prevent damage to processes, equipment or people by conducting static charges away at a rate that prevents damage.



In order to ensure the ESD features work effectively, it is important that the instructions below are followed. Failure to do so could render the ESD system ineffective.

#### 14.11.1 Construction clean

- ▶ Sweep, mop sweep or dry vacuum the floor, to remove dust, grit and debris.
- ▶ For light soiling  
Damp mop the floor with a neutral cleanser, diluted to the manufacturer's instructions.

Or

- ▶ For heavy soiling  
Apply a solution of alkaline cleanser, diluted to the manufacturer's instructions, to the floor and leave for sufficient time to react with the soiling. Using a 165 to 350 rpm rotary machine fitted with a scrubbing pad, machine scrub the floor and then pick up the slurry with a wet vacuum. Rinse the floor thoroughly with clean warm water, pick up with a wet vacuum and leave to dry thoroughly.

#### 14.11.2 Application of a Floor Dressing

Normal, commercially available polishes should **not** be applied to Polyflor ESD products, as they will inhibit the conductive properties. Polishes described as 'antistatic' are classified by a different standard from that of the floor covering, and should be treated as a standard polish in static control terms. Consequently, they should not be applied.

Conductive polishes which are approved by Polyflor can be applied in strict accordance with the manufacturer's instructions. Prior to application of a floor dressing, ensure that the floor is thoroughly scrubbed. This will ensure that there is a good key between the dressing and the surface of the flooring.

**KEY POINT**  
Before applying conductive polish always discuss with **Polyflor CTSD**.



### 14.11.3 Regular maintenance

The frequency of each of the operations is dependent upon the type and intensity of traffic.

- ▶ Sweep, mop sweep or dry vacuum, to remove dust and loose dirt.
- ▶ Spot mop frequently. Stubborn black marks can be removed by using the centre disc of a scrubbing pad and a small amount of undiluted alkaline cleanser. Place the disc under the sole of the shoe and rub; this gives greater pressure. Rinse the area well with clean, warm water and allow to dry.

Depending upon the end user requirement and the equipment available, one of the following methods should be used:

- ▶ Using an alkaline or germicidal cleanser, diluted to the manufacturer's instructions, spray a fine mist onto the floor. Using a 165 to 1000 rpm rotary machine and suitable spray cleaning pad, buff the floor to the desired shine. The dirt is picked up in the pad, which should be thoroughly cleaned after use. Failure to do so will result in a shiny, dirty floor.

### 14.11.4 Additional Information

- ▶ Always ensure mops and pads are kept specifically for the static control areas, to prevent a possible transfer of polish.
- ▶ Always follow the Health and Safety guidance provided.
- ▶ Regular cleaning is more beneficial to the floor covering and more cost-effective than occasional heavy cleaning.

## 14.12 RUBBER FLOOR COVERINGS

### 14.12.1 Construction clean



After installation, wait 48 hours before proceeding with the construction and intensive clean.

- ▶ Sweep or dry vacuum the floor to remove dust, grit and debris.
- ▶ Apply a solution of alkaline cleanser, diluted as per the manufacturer's instructions, to the floor and leave for at least 5 minutes (or longer if manufacturer recommends) to react before proceeding.
- ▶ Using a 165 rpm rotary machine fitted with fibre or nylon brushes, machine scrub the floor and then pick up the slurry with a mop or wet vacuum. The floor should then be rinsed with clean water and allowed to dry.

### 14.12.2 Application of a floor dressing

- ▶ Prior to the application of a floor dressing, ensure that the floor is completely stripped, clean and free from any contaminants. This will ensure that there is a good key between the dressing and the surface of the floor.
- ▶ Apply two or three thin coats of emulsion polish, in accordance with the manufacturer's instructions, with either a proprietary polish applicator or Kentucky mop wrung out to prevent over-application of polish. The polish should be applied up to 150mm from the edges of the room, and subsequent coats should be applied at 90° to the previous one. The final coat should be applied right up to the edges of the room.

### 14.12.3 Routine maintenance

For ongoing maintenance, the frequency of each of the operations should be adjusted to suit the appearance expectations and the type and intensity of traffic.

- ▶ Sweep or dry vacuum daily, to remove dust and loose dirt.
- ▶ Spot mop frequently. Rinse the area with clean, warm water and allow to dry.
- ▶ As required (normally at least once per week) mop the floor using a floor maintainer, diluted as per the manufacturer's instructions, and leave to dry. If a shine is required, the floor should be buffed with a low-speed machine, typically 165 rpm, fitted with suitable fibre or nylon brushes.
- ▶ Regular buffing of the floor covering will enhance its appearance.

### 14.12.4 Removal of a floor dressing

An unsightly build-up of polish should be avoided. The polish should be removed regularly; the interval between application and removal depends on the wear conditions and the number of polish layers (normally, six months in heavy traffic areas).

- ▶ Apply a solution of emulsion polish stripper, dilute to the manufacturer's instructions, to the floor and leave for approximately 15 minutes.

#### KEY POINT

When high speed burnishing, it is important that the machine is kept constantly moving. This avoids excessive heat build-up on the floor. As an additional precaution, we advise that a spray of clean water is used, to help lubricate the pad.

- ▶ Machine scrub with a 165 rpm machine fitted with a scrubbing brush, and then remove slurry with a wet vacuum. Thoroughly rinse the floor with clean warm water, pick up with a wet vacuum and allow to dry completely. The cycle of polish application and routine maintenance should then be repeated.

#### 14.12.5 Additional Information

- ▶ Always follow the Health and Safety guidance provided.
- ▶ Regular cleaning is more beneficial to the floor covering and more cost-effective than occasional heavy cleaning.
- ▶ Polyflor rubber floor coverings are suitable for steam cleaning on a periodic basis.

### 14.13 TIPS, HINTS AND PROBLEM SOLVING

The main objective of the tailored maintenance programme is to provide cost savings without any compromise in cleanliness and hygiene.

Bearing this in mind, the most important tip is to regularly assess the various locations and be flexible about the maintenance employed in them. If the floor in a particular location needs more attention, then ensure that this is addressed as soon as possible. If some areas seem over-maintained (with polish build-up, perhaps, in the non-trafficked areas), then pull back the maintenance level, but always monitor the situation to ensure that it remains within control. In addition, there are certain precautions which can be taken.

#### 14.13.1 Asphalt and Tarmacadam

Where asphalt or tarmacadam is present immediately outside an entrance and there is not a sufficient dirt barrier system in place, use non-rubber traffic mats at least two paces wide. Staining of the floor may occur if traffic mats are not used.

#### 14.13.2 Gravel Paths and Roadways

Traffic mats should also be considered when gravel paths or roadways are immediately outside an entrance. Always clean mats frequently.

#### 14.13.3 Rubber Tyres etc.

Antioxidants used in the manufacture of rubber can cause staining. Non-rubber traffic mats are recommended, as are tyre trays for car showrooms. Using black or dark brown floor coverings will not prevent staining but will disguise it. Lighter coloured rubber can also be specified for appliance feet, trolley wheels etc.

#### 14.13.4 Scratches

Prevention is the first step to protecting vinyl flooring from scratches:

- ▶ Use mats at external doorways to reduce the trafficking of grit, dust and water into the building.
- ▶ Furniture can cause scratches to a vinyl floor, therefore appropriate protection (felt pads, etc.) should be attached to the feet of furniture such as tables and chair legs.
- ▶ Keeping pets nails well clipped will reduce the likelihood of scratching from pets.

#### 14.13.5 Points to Note

- ▶ Regular light maintenance is more cost effective than periodic heavy maintenance and more beneficial to the floor covering.
- ▶ Always sweep, mop sweep or dry vacuum the floor regularly.
- ▶ Always use clean equipment – dirty equipment only redistributes the dirt.
- ▶ Do not mix cleaning products from different manufacturers – they may not be compatible.
- ▶ Always remove any spillage immediately. Always remove excess water. It is not only dangerous but, on unwelded tile floors, the water can attack the adhesive and break the bond.
- ▶ Do not use products containing pine gel or phenolic acid on Polyflor vinyl flooring. These can soften the vinyl surface and increase the possibility of scuffing. Shrinkage of the vinyl can also occur in the long term.
- ▶ Never apply a floor dressing which cannot easily be removed – such as polyurethane or acrylic sealers – unless approved by Polyflor.
- ▶ Never deviate from the manufacturer's recommended dilution rates.
- ▶ Always take precautions to prevent dark rubber from coming into contact with the flooring. If this cannot be avoided, select darker colours of floor covering.
- ▶ Never use abrasive pads on the flooring.
- ▶ Only use water based floor maintenance products.

#### 14.13.6 Problem Solving

In our experience most floor care complaints arise from a general comment that the floor is not as clean as expected. The most common reason is usually that the maintenance method being applied is not compatible with the type and level of traffic found.

The table below contains more specific problems with their causes and our recommended actions.

COMMON PROBLEM	POSSIBLE CAUSE	RECOMMENDED ACTION
Powdering of polish/ excess of white dust	Breakdown of polish due to either excessive use of alkaline cleansers, inadequate rinsing, use of bleaches or other harsh chemicals.	Strip off polish, thoroughly rinse and when dry, re-apply.
Poor gloss, streaks or patchy finish.	Polish could be applied to a dirty floor. Polish could have been applied with dirty equipment. A residue of alkaline cleanser is on the floor.	Strip off polish, thoroughly rinse and when dry, re-apply.
Polished floor is slippery.	Incorrect polish type applied. Application of too much or too little polish. Polish build up. Surface contaminants such as water or dust are not being removed. Cross trafficking	If polish is identified as the problem, strip off and re-apply. Ensure daily maintenance to remove dust and other surface contaminants. If cross trafficking is a problem, use walk off mats.
Sticky floors.	Polish may not be dry. There may be a detergent build up.	Strip off polish and re-apply. Ensure adequate rinsing after use of detergent to avoid build up.
Fading colour.	Equipment contaminated with bleach or bleach based products used.	Ensure all cleaning equipment is clean before use.
We strongly advise that a reputable professional maintenance company is used to provide chemicals and equipment. Always ask for help and advice sooner rather than later. A problem solved sooner is a problem solved cheaper.		

#### 14.14 HEALTH AND SAFETY

When using cleaning machines, polishes and chemicals, always follow the health and safety advice given by the relevant manufacturers.

When maintaining floors, wherever possible cordon off the area. This is much safer and will ensure that the job can be completed quicker.

Always use warning signs to advise that cleaning is in progress, especially in heavily trafficked areas and where wet cleaning methods are used.

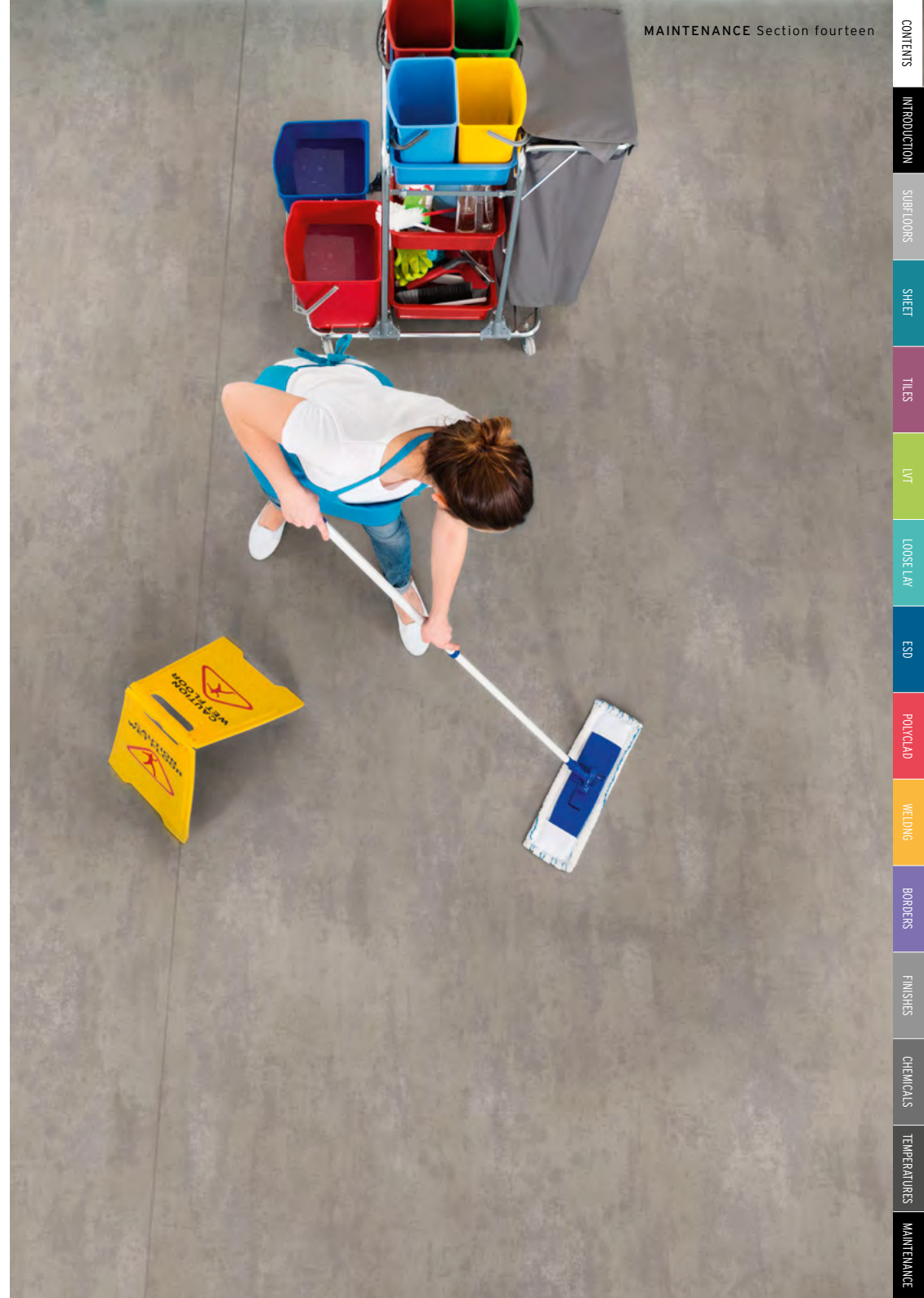



## TAKE YOUR FIRST STEPS TO RECYCLING POLYFLOR VINYL FLOORING

Register with Recofloor to receive Recofloor bags & arrange collections

**OR** Pick up Recofloor bags from the trade counter at participating distributors

Place waste vinyl flooring into Recofloor bags

Call Recofloor to collect waste vinyl flooring (save up to 75% on disposal costs)

**OR** Drop off and recycle at over 60 sites across UK & Ireland (FOC)



### REGISTER



### YES, PLEASE

- ✓ Post installation, smooth or safety vinyl offcuts
- ✓ Old stock smooth or safety vinyl roll ends or samples
- ✓ Smooth, clean uplifted flooring

### DROP-OFF SITE DIRECTORY



[www.recofloor.org](http://www.recofloor.org)

## REAP THE REWARDS

### For the ENVIRONMENT



- ✓ Reduces waste sent to landfill
- ✓ Recycled into new flooring
- ✓ Recycled into useful products
- ✓ Reduces carbon footprint

### For YOU & YOUR BUSINESS



Steve Dixon, S & D Flooring Specialists Ltd., Hull

*"We have contracts with our local council and a partnership with a commercial modular building company, so offering a vinyl flooring recycling service ticks all the right boxes for these clients. Recofloor helps us to differentiate our company in a really positive way."*

- ✓ Enjoy FREE entry to the Recofloor Annual Awards
- ✓ Benefit from the scheme's publicity & PR
- ✓ Hassle-free waste management
- ✓ Contributes to points on BREEAM assessments
- ✓ Save up to 75% on waste disposal costs
- ✓ Certificates of commitment & awards to enhance your green credentials, helping you to win more business

## SIGN UP TODAY & JOIN US AT THE NEXT RECOFLOOR AWARDS



### Contact RECOFLOOR

-  0161 355 7618
-  [info@recofloor.org](mailto:info@recofloor.org)
-  [www.recofloor.org](http://www.recofloor.org)



**Australia**  
Polyflor Australia  
Tel: +61 3 9215 4400  
Tel: 1800 777 425  
E-mail: sales@polyflor.com.au

**Canada**  
Polyflor Canada Inc.  
Tel: +1 905 364 3000  
E-mail: sales@polyflor.ca

**China**  
Polyflor Hong Kong  
Tel: +(852) 2865 0101  
E-mail: info@polyflor.com.hk

**France**  
James Halstead France SAS  
Tel: +33 (0) 8 20 20 32 11  
E-mail: info@jhfrance.fr

**Germany**  
objectflor Art und Design Belags GmbH  
Tel: +49 (0) 2236 966 330  
E-mail: info@objectflor.de

**India**  
Polyflor India Pvt Ltd  
Tel: +91 22 4023 2485  
E-mail: info@polyflor.co.in

**Ireland**  
Polyflor Ireland  
Tel: +353 (1) 864 9304  
E-mail: salesireland@polyflor.com

**New Zealand**  
Polyflor New Zealand Ltd  
Tel: +64 9 269 1111  
Tel: 0800 765 935  
E-mail: sales@polyflor.co.nz

**Norway**  
Polyflor Nordic  
Tel: +47 23 00 84 00  
E-mail: firmapost@polyflor.no

**Poland**  
Polflor Sp. Z o.o.  
Tel: +48 (0) 61 820 3155  
E-mail: polyflor@polflor.com.pl

**South Africa**  
Poly Sales Africa (Pty.) Ltd  
Tel: +27 (0) 11 609 3500  
E-mail: info@polyflor.co.za

**Sweden**  
FalckDesign AB  
Tel: +46 (0) 300 15820  
E-mail: info@falckdesign.com

## **POLYFLOR™ UK**

Polyflor Ltd. PO Box 3, Radcliffe New Road  
Whitefield, Manchester, M45 7NR

Customer Technical Services Department: +44 (0) 161 767 1912

Reception: +44 (0) 161 767 1111

E-mail: tech@polyflor.com

www.polyflor.com